



High Torque Performance and Precise Control

# STARVERT *iS7*

0.75~75kW 3Phase 200 ~ 230Volts  
0.75~375kW 3Phase 380 ~ 480Volts





# User-Friendly Options

Diverse communication options, expansion I/O options,  
PLC options, encoder options, IP54 enclosure options



## Contents

- 04 Features
- 10 Model & Type
- 11 Specifications
- 14 Dimensions

iS7 generates a more powerful performance through its superior V/F control, V/F PG, slip compensation, and sensorless vector control. The iS7 focuses on a user-friendly interface and environment-friendly features including a wide graphic LCD keypad, user & macro group support, electro-thermal functions for motor protection, and protection for input/output phase loss.



The iS7 sets the world standard for drives (VFDs) because of its features that meet all of your needs in AC drives. The iS7 offers powerful performance, flexibility through diverse options, and a more convenient and user-friendly interface. The iS7 offers more than you can imagine.



**iS7** is dependable because it has high performance and reliability.



iS7 Feature | Reliability & High Performance

# Reliability

- ▶ Powerful electric current type sensorless vector control  
Our iS7 technology includes a competitive and strong low-speed torque control and a speed-precision-driven vector algorithm.
- Speed control range 100:1
- Extremely low torque control capability: 0.1Hz/150% real torque
- Max. torque control capability within the restoration range

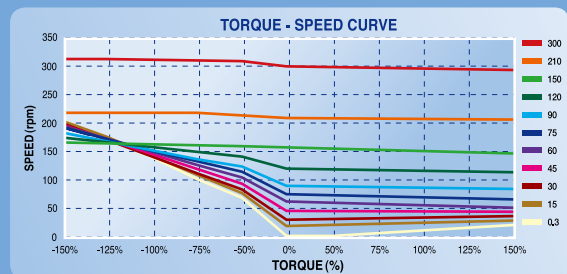

# High Performance

- **Sensored vector realizing precise speed/torque control**  
 In the entire speed range including zero speed, powerful torque (more than 250%) performance is materialized through receiving Max. 200kHz frequency pulse via encoder-dedicated board.
  - Speed control range 1000:1
  - Instant Max. torque control capability 250%
  - 50Hz speed control response

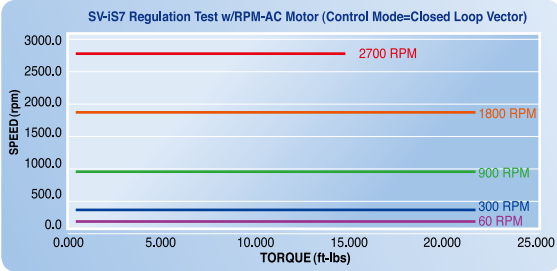

- **Ride-through (LV trip delay) for sudden power loss**

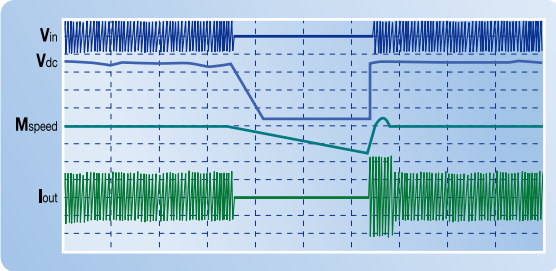

# Powerful Performance

V/F control, V/F PG, slip compensation, sensorless vector control

- **Automatic torque balance droop control**  
 Droop control algorithm adjusts changeable torque driven by speed. This algorithm is easily applicable to open loop linking driving and load sharing driving.

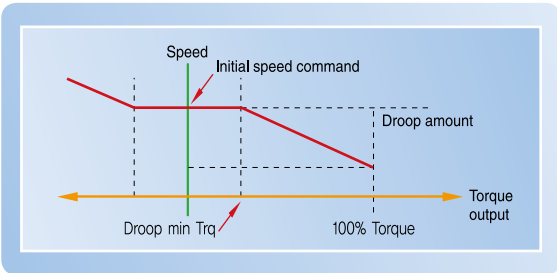

- **Kinetic Energy Buffering (KEB) for a stable system stop in case of power loss or failure**

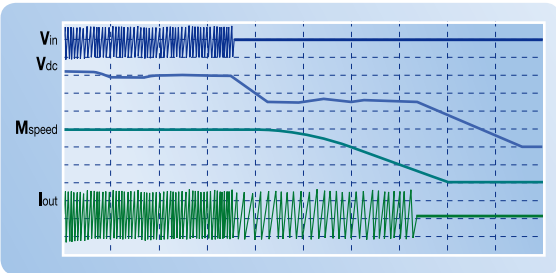

- **Easy start parameter setting**



- **Power and flux braking for maximum deceleration**

**iS7** is flexible because it is easily expandable.

## User-Friendly Options

Diverse communication options, expansion I/O options, PLC options, encoder options, IP54 enclosure options

iS7 Feature | Flexibility & Expansion

# Flexibility

- ▶ iS7 offers options with flexibility and expandability.
  - Built-in Built in RS485 & Modbus-RTU communication
  - Profibus-DP, DeviceNet, LonWorks options
  - Expandable I/O options: Max. input 11 points, Max. output 6 points
  - PLC options: Max. input 14 points, Max. output 7 points for Master-K platform
  - Encoder options
  - IP54 enclosure options

### ▶ PLC Card

- Master-K 120S platform
- Normal input 6 points (Sink/Source selectable), Max. input 14 points when expanded
- Normal output 4 points (N.O. Relay), Max. output 7 points when expanded
- RTC (Real Time Clock)
- KGL WIN operating system



### ▶ Encoder Card

- Closed loop control
- Pulse train reference
- 5/12/15 V insulated power supply
- Line driver or open collector
- 200kHz Max. input frequency
- Signal loss detection



### ▶ Profibus-DP Card

- Profibus dedicated connector
- Max. 12Mbps communication speed
- Max. 32 stations per segment
- Bus topology
- Enhanced on-line diagnosis



▶ **Ethernet Card**

- Modbus TCP, Ethernet IP Protocol support
- 10Mbps, 100Mbps communication speed
- Half duplex, full duplex support
- Auto negotiation
- Max. 100m(328ft.) transmission distance
- CSMA/CD communication access method



▶ **LonWorks**

- 78kbps communication speed
- Free/bus topology
- Resistance built-in per topology
- Max. 2700m (8858 ft.) connection distance (bus topology)



▶ **DeviceNet**

- Communication speed: 125kbps, 250kbps, 500kbps
- Free/Bus topology
- Max. 64 node connection points
- Max. 500m (1640 ft.) transmission distance (125kbps)



▶ **I/O Expansion Card**

- Insulated I/O 3 points each
- Ext-1  
Analog voltage (-10~10V) I/O 1 point  
Analog current (0~20mV) I/O 1 point
- Ext-2  
Analog voltage (-10~10V) I/O 2 points  
Analog current (0~20mV) I/O 2 points



▶ **R-Net Card**

- 1Mbps Communication speed
- Manchester Biphase-L Frame synchronization
- Max. 64 node connection points
- Max. 750m transmission distance (segment each)



▶ **Built-in RS485 & Modbus-RTU**

- Multi drop link focused RS485, Modbus built-in
- Connecting up to 16 AC drives
- Max. 1200m (3937 ft.) communication distance (valid distance: 700m (2297 ft.))
- Protection algorithm under command lost
- Real time running and monitoring with drive view software

▶ **CanOpen Card**

- 1Mbps communication speed
- Bus Topology
- Max. 64 node connection points (include master)
- PDO, SDO, Sync, NMC communication support
- Support profile:  
PDO1 (CiA402 drive & motion control device profile)  
PDO3 (LS Profile)



▶ **CC-Link Card**

- 10Mbps communication speed
- Connecting up to 42 AC drives
- Station type: Remote device station
- 1 connection point for 1 AC drive

▶ **Drive Copy Unit (UX-07V1)**

- Support products: iS7, iE5
- Support function:  
Parameter copy, RS485 converter
- Copy speed: 9,600bps (iE5) / 19,200bps (iS7)
- Max. save paramete: 5 Sets
- Converter support speed:  
1,200 / 2,400 / 9,600 / 19,200 / 38,400 bps

**iS7** is convenient because it has a user friendly interface.



iS7 Feature | Convenience & Environment

# Convenience Environment

- ▶ EMC filter (in conformity with EN61800-3) built-in for protection from excessive electronic distortion

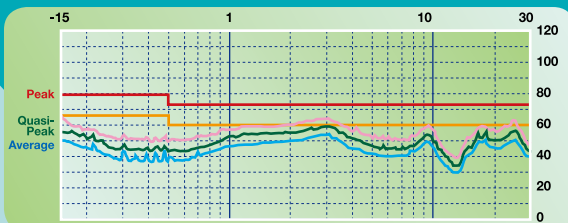
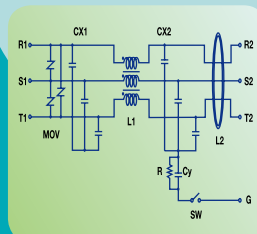

- ▶ DC reactor built-in for harmonic reduction and power factor improvement



Overloading rate	110% (VT rated standard)
THD	18 ~ 37%
power factor	94 ~ 96%
IP Level	IP21
Insulation Class	155□□ (300□□)



Input current and THD analysis

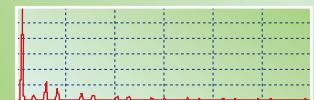

THD : 29.3%      PF : 95.9%



➤ Widened graphic LCD keypad

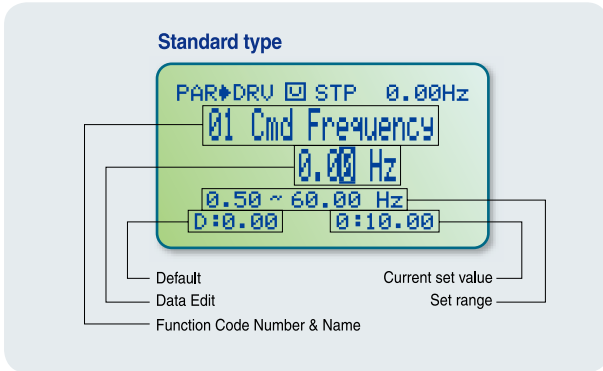

➤ Multi-language support (5 languages)

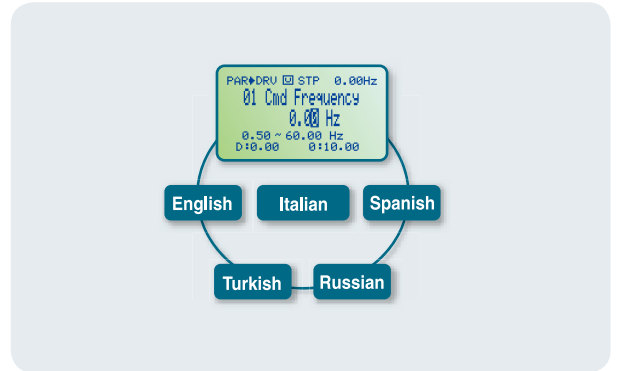

# Convenience through User-friendly Interface

➤ Efficient architecture of 5-mode 15-parameter groups

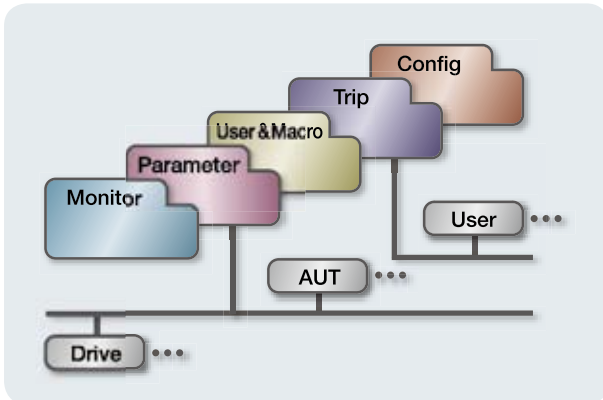

➤ User & macro group support

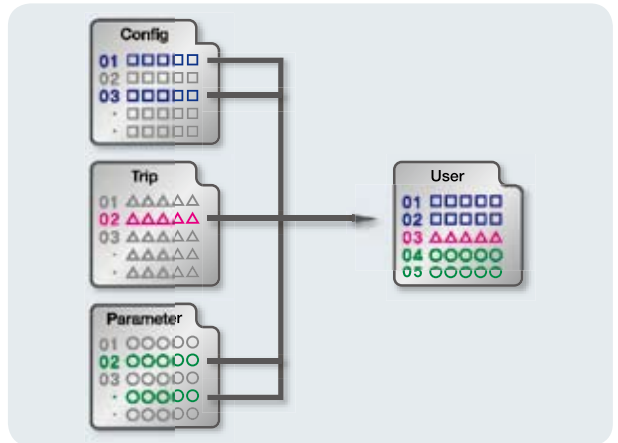

➤ Multi-function key

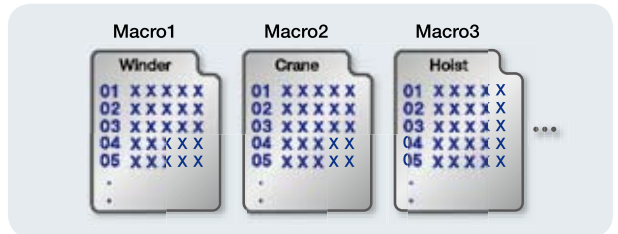
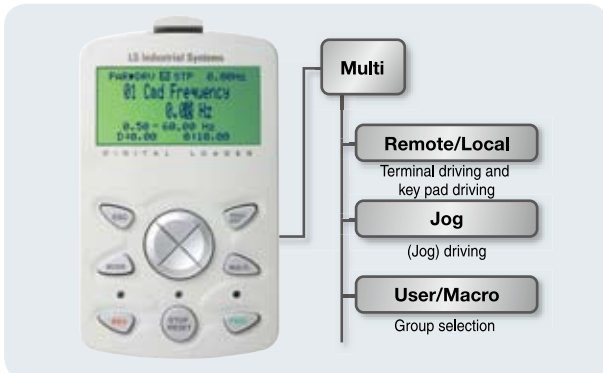

➤ Protective functions dedicated motor control



## Model and Type

Applied motors	220V class	400V class
0.75kW	SV0008 iS7-2NOFD	SV0008 iS7-4NOFD
1.5kW	SV0015 iS7-2NOFD	SV0015 iS7-4NOFD
2.2kW	SV0022 iS7-2NOFD	SV0022 iS7-4NOFD
3.7kW	SV0037 iS7-2NOFD	SV0037 iS7-4NOFD
5.5kW	SV0055 iS7-2NOFD	SV0055 iS7-4NOFD
7.5kW	SV0075 iS7-2NOFD	SV0075 iS7-4NOFD
11kW	SV0110 iS7-2NOFD	SV0110 iS7-4NOFD
15kW	SV0150 iS7-2NOFD	SV0150 iS7-4NOFD
18.5kW	SV0185 iS7-2NOFD	SV0185 iS7-4NOFD
22kW	SV0220 iS7-2NOFD	SV0220 iS7-4NOFD
30kW	SV0300 iS7-2SO	SV0300 iS7-4NOD
37kW	SV0370 iS7-2SO	SV0370 iS7-4NOD
45kW	SV0450 iS7-2SO	SV0450 iS7-4NOD
55kW	SV0550 iS7-2SO	SV0550 iS7-4NOD
75kW	SV0075 iS7-2SO	SV0750 iS7-4NOD
90kW		SV0900 iS7-4SOD
110kW		SV1100 iS7-4SOD
132kW		SV1320 iS7-4SOD
160kW		SV1600 iS7-4SOD
185kW		SV1850iS7-4SOD
220kW		SV2200iS7-4SOD
280kW		SV2800iS7-4SO
315kW		SV3150iS7-4SO
375kW		SV3750iS7-4SO

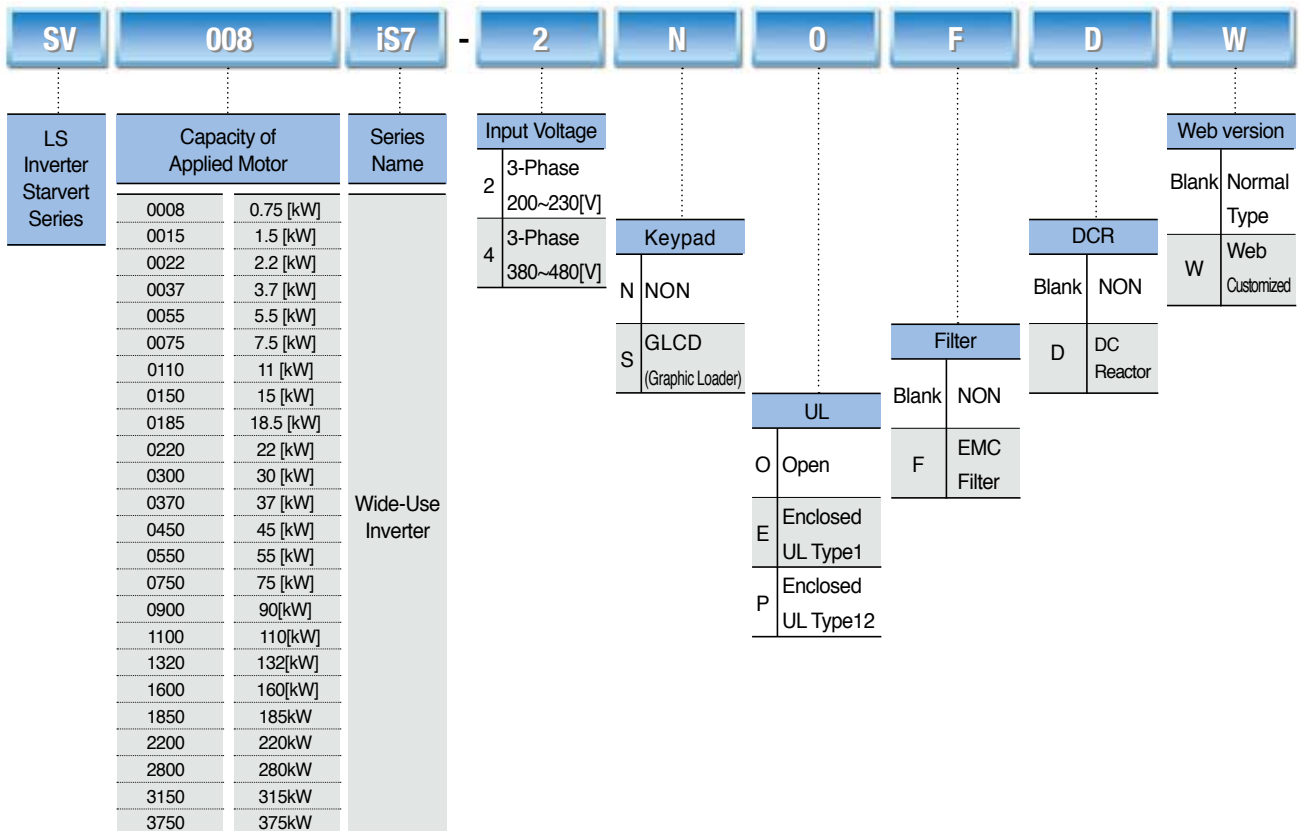

## Specification

### Rated Input and Output: Input voltage of 200V class (0.75~22kW)

Type: SV □□□ iS7-2 □		0008	0015	0022	0037	0055	0075	0110	0150	0185	0220	
Motor Applied *1)	[HP]	1	2	3	5	7.5	10	15	20	25	30	
	[kW]	0.75	1.5	2.2	3.7	5.5	7.5	11	15	18.5	22	
Rated Output	Rated Capacity [kVA] *2)	1.9	3.0	4.5	6.1	9.1	12.2	17.5	22.9	28.2	33.5	
	Rated Current [A] *3)	CT	5	8	12	16	24	32	46	60	74	88
		VT	8	12	16	24	32	46	60	74	88	124
	Output Frequency [Hz]	0 ~ 400 [Hz] *4)										
Output Voltage [V]	3-phase 200 ~ 230V *5)											
Rated Input	Available Voltage [V]	3-phase 200 ~ 230 VAC (-15% ~ +10%)										
	Frequency [Hz]	50 ~ 60 [Hz] (±5%)										
	Rated Current [A]	CT	8.3	12.9	18.6	24	32.9	41.4	58	69	88	96
VT		7	10.6	14.8	21.5	28	42	52	60	75	107	

### 2.1.2 Rated Input and Output: Input voltage of 200V class (30~75kw)

Type: SV □□□ iS7-2 □		0300	0370	0450	0550	0750	-	-	-	-	-	
Motor Applied	[HP]	40	50	60	75	100	-	-	-	-	-	
	[kW]	30	37	45	55	75	-	-	-	-	-	
Rated Output	Rated Capacity [kVA] *2)	46	57	69	84	116	-	-	-	-	-	
	Rated Current [A] *3)	CT	116	146	180	220	288	-	-	-	-	-
		VT	146	180	220	288	345	-	-	-	-	-
	Output Frequency [Hz]	0 ~ 400 [Hz] *4) (Sensorless -1: 0 ~ 300Hz, Sensorless -2, Vector. 0 ~ 120Hz)										
Output Voltage [V]	3-phase 200 ~ 230V *5)											
Rated Input	Available Voltage [V]	3-phase 200 ~ 230 VAC (-15% ~ +10%)										
	Input Frequency	50 ~ 60 [Hz] (±5%)										
	Rated Current [A]	CT	121	154	191	233	305	-	-	-	-	-
VT		152	190	231	302	362	-	-	-	-	-	

\* Non DCR products are provided warranty service when used in CT (Heavy duty) load rating only.

### Rated Input and Output: Input voltage of 400V class (0.75~22kW)

Type: SV □□□ iS7-4 □		0008	0015	0022	0037	0055	0075	0110	0150	0185	0220	
Motor Applied *1)	[HP]	1	2	3	5	7.5	10	15	20	25	30	
	[kW]	0.75	1.5	2.2	3.7	5.5	7.5	11	15	18.5	22	
Rated Output	Rated Capacity [kVA] *2)	1.9	3.0	4.5	6.1	9.1	12.2	18.3	22.9	29.7	34.3	
	Rated Current [A] *3)	CT	2.5	4	6	8	12	16	24	30	39	45
		VT	4	6	8	12	16	24	30	39	45	61
	Output Frequency [Hz]	0 ~ 400 [Hz] *4)										
Output Voltage [V]	3-phase 380 ~ 480V *5)											
Rated Input	Available Voltage [V]	3-phase 380 ~ 480 VAC (-15% ~ +10%)										
	Frequency	50 ~ 60 [Hz] (±5%)										
	Rated Current [A]	CT	4.3	7.2	10.6	15.4	21	25.8	38.7	43.85	56.9	57.4
VT		3.5	5.3	7.3	10.8	13.8	22.5	26.1	33.2	40	52.2	

\*1) Motor Applied indicates the maximum capacity of a standard 4 pole OTIS-LG motor.

\*2) Rated Capacity: the input capacity of a 200V class is based on 220V and that of a 400V class is based on 440V. The current rating is based on CT current.

\*3) The output of rated current is limited according to the setting of the carrier frequency (CON-04).

\*4) You can set the frequency at up to 300Hz by selecting 3, 4 Sensorless-1, Sensorless-2 as the control mode (DRV-09 Control Mode).

\*5) The maximum output voltage does not go over the supplied power voltage. You can select the output voltage as you want below the supplied power voltage.



## Specifications

### Rated Input and Output: Input voltage of 400V class (30~375kW)

Type: SV □□□iS7-4 □		0300	0370	0450	0550	0750	0900	1100	1320	1600	1850	2200	2850	3150	3750	
Motor Applied *1)	[HP]	40	50	60	75	100	120	150	180	225	250	300	375	420	500	
	[kW]	30	37	45	55	75	90	110	132	160	185	220	285	315	375	
Rated Output	Rated Capacity [kVA] *2)	46	57	69	84	116	139	170	201	248	286	329	416	467	557	
	Rated Current [A] *3)	CT	61	75	91	110	152	183	223	264	325	370	432	547	613	731
		VT	75	91	110	152	183	223	264	325	370	432	547	613	731	877
	Output Frequency [Hz]	0 ~ 400 [Hz] (Sensorless-1: 0 ~ 300Hz, Sensorless-2, Vector: 0 ~ 120Hz) *4)														
	Output Voltage [V]	3-phase 380 ~ 480V *5)														
Rated Input	Available Voltage [V]	3-phase 380 ~ 480 VAC (-15% ~ +10%)														
	Frequency [Hz]	50 ~ 60 [Hz] (±5%)														
	Rated Current [A]	CT	57	69	83	113	154	195	239	286	362	404	466	605	674	798
VT		90	109	123	162	195	237	282	350	403	463	590	673	796	948	

\*1) Motor Applied indicates the maximum capacity of a standard 4 pole OTIS-LG motor.

\*2) Rated Capacity: the input capacity of a 200V class is based on 220V and that of a 400V class is based on 440V. The current rating is based on CT current.

\*3) The output of rated current is limited according to the setting of the carrier frequency (CON-04).

\*4) You can set the frequency at up to 300Hz by selecting 3, 4 Sensorless-1, Sensorless-2 as the control mode (DRV-09 Control Mode).

\*5) The maximum output voltage does not go over the supplied power voltage. You can select the output voltage as you want below the supplied power voltage.

### Control

Control Method	V/F control, V/F PG, slip compensation, sensorless vector control, vector control
Frequency Setting Resolution	Digital command: 0.01Hz Analog command: 0.06Hz (maximum frequency: 60Hz)
Frequency Tolerance	Digital command operation: 0.01% of the maximum frequency Analog command operation: 0.1% of the maximum frequency
V/F Pattern	Linear, double reduction, user V/F
Overload Capacity	CT current rating :150% for 1 minute, 200% for 22 seconds, VT current rating :110% for 1 minute
Torque Boost	Manual torque boost, automatic torque boost

## Specifications

### Specifications

Operating Method		Selectable among keypad/terminal block/communication operation	
Frequency Setting		Analog: 0 ~ 10[V], -10 ~ 10[V], 0 ~ 20[mA] Digital: keypad	
Operating Function		PID control, up-down operation, 3-wire operation, DC brake, frequency limit, frequency jump, second function, slip compensation, reverse rotation prevention, auto restart, inverter by-pass, auto tune flying start, energy buffering, power braking, flux braking, leakage current reduction, MMC, easy start	
Input	Multi-function terminal (8 points) P1 ~ P81 <sup>*1)</sup>	NPN / PNP selectable	
		Function: forward operation; reverse operation; reset; external trip; emergency stop; jog operation; sequential frequency-high; medium and low; multi-level acceleration and deceleration-high; medium and low; D.C. control during stop; selection of a second motor; frequency increase; frequency decrease; 3-wire operation; change to general operation during PID operation; main body operation during option operation; analog command frequency fixation; acceleration and deceleration stop selectable	
Output	Multi-function open collector terminal	Inverter fault output	Below DC 24V 50mA
	Multi-function relay terminal		Below (N.O., N.C.) AC250V 1A, Below DC 30V 1A
	Analog output	0 ~ 10 Vdc (below 10mA): selectable from frequency, current, voltage, direct current voltage	

<sup>\*1)</sup> The Functions for Multi-function terminal available according to IN-65~72 parameter setting of IN Group.

### Protective Functions

Trip	Over voltage, low voltage, over current, over current detection, inverter overheat, motor thermal protection, phase loss protection, overload protection, communication error, frequency command loss, hardware failure, cooling fan failure, pre-PID failure, no motor trip, external brake trip. etc
Alarm	Stall prevention, overload, diminished load, encoder error, fan failure, keypad command loss, speed command loss.
Instantaneous Interruption <sup>*2)</sup>	Below CT class 15 msec (VT class 8 msec): operation continues (within rated input voltage, rated output) Over CT class 15 msec (VT class 8 msec): automatic restart

<sup>\*2)</sup> Operation at the CT (Heavy Duty) current rating

### Structure and Use Environment

Cooling Method	Forced air blast cooling: 0.75 ~ 15kW (200/400V class), 22kW (400V class) Inhalation cooling: 22 ~ 75kW (200V class), 30 ~ 160kW (400V class)
Protection Structure	Below 75kW: Open Type(IP21), UL enclosed type 1 (Option) <sup>*3)</sup> 30 ~ 75kW 200V, Above 90kW: Open type(IP00) The others (Below 22kW): Enclosed IP54 type, UL enclosed type 12
Surrounding Temperature	CT (Heavy Duty) load: -10 ~ 50°C, (14 ~ 122°F) without ice or frost VT (Normal Duty) load: -10~ 40°C (14 ~ 122°F) without ice or frost (It is recommended that you use less than 80% load when you use VT load at 50°C (122°F)) IP54 product: -10~40°C (14~122°F) without ice or frost
Preservation Temperature	-20 ~ 65°C (-4 ~ 149°F)
Surrounding Humidity	Below 90% RH of relative humidity (with no dew formation)
Altitude, Vibration	Below 1,000m (3280 ft), below 5.9m/sec 2 (19.36 ft/sec 2, 0.6G)
Environment	There should be no corrosive gas, flammable gas, oil mist or dust. Pollution Degree 2 Environment

<sup>\*3)</sup> UL Enclosed type 1 with conduit box installed



## Dimensions

### SV0008 ~ 0037iS7 (200V/400V)

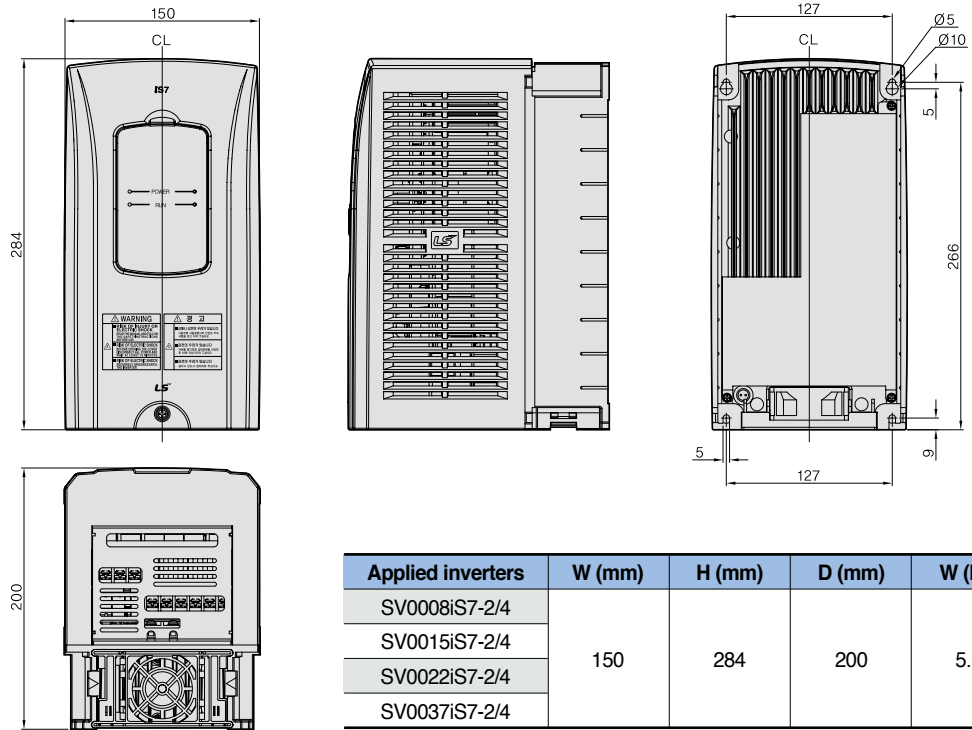

\* The weight above represents the total weight including EMC filter and DCL.

### SV0055 ~ 0075iS7 (200V/400V)

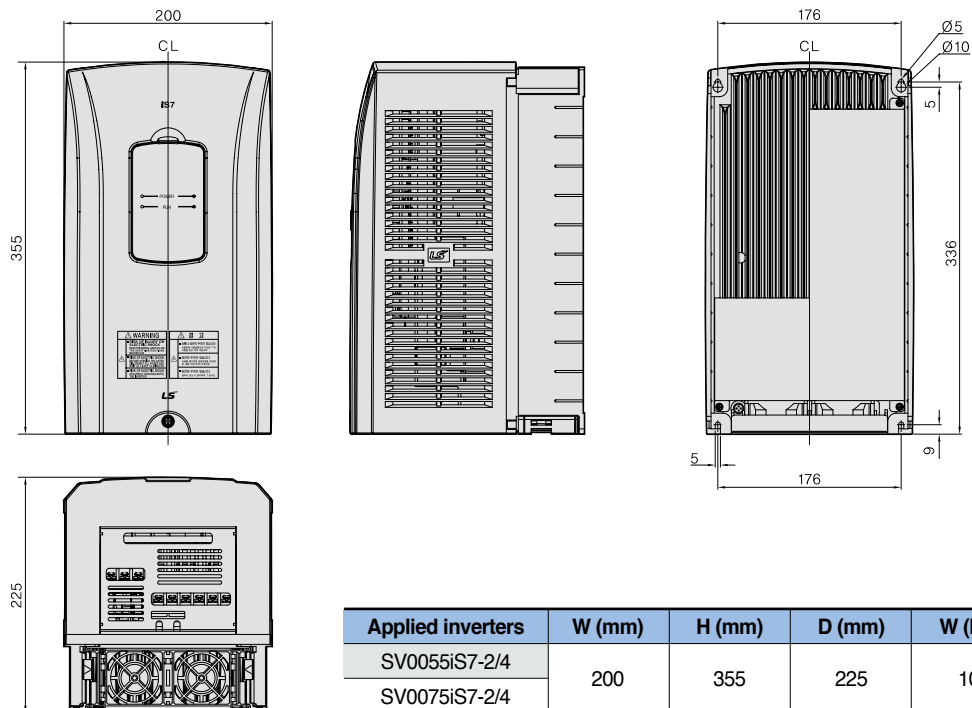

\* The weight above represents the total weight including EMC filter and DCL.

## Dimensions

### SV0110 ~ 0150iS7 (200V/400V)

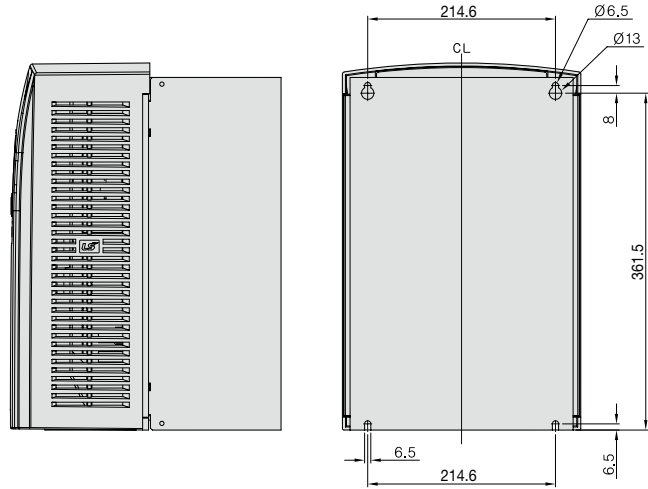
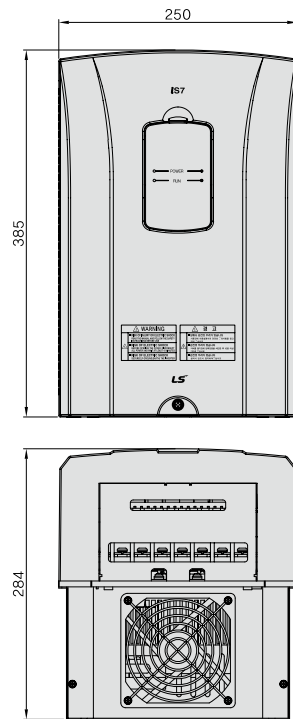

Applied inverters	W (mm)	H (mm)	D (mm)	W (kg)
SV0110iS7-2/4	250	385	284	20
SV0150iS7-2/4				

\* The weight above represents the total weight including EMC filter and DCL.

### SV0185 ~ 0220iS7 (200V/400V)

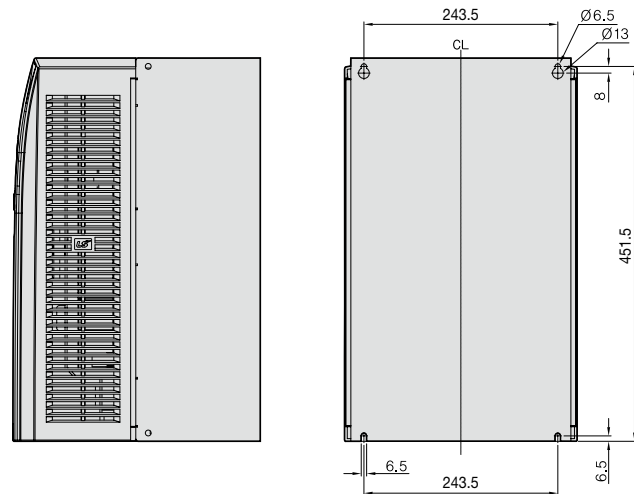
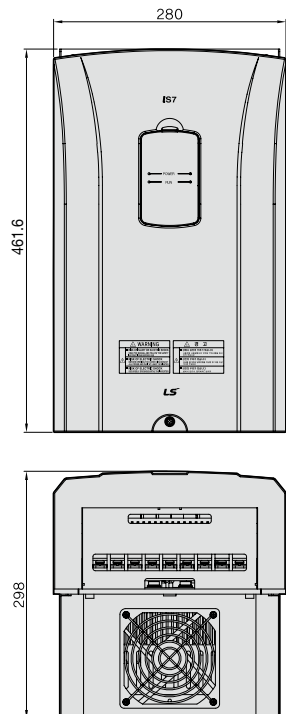

Applied inverters	W (mm)	H (mm)	D (mm)	W (kg)
SV0185iS7-2	280	461.6	298	30
SV0220iS7-2				
SV0185iS7-4				
SV0220iS7-4				

\* The weight above represents the total weight including EMC filter and DCL.



## Dimensions

### SV0300iS7 (200V)

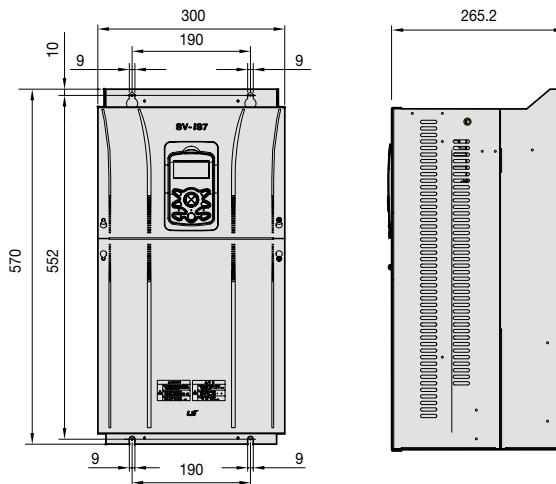

Applied inverters	W (mm)	H (mm)	D (mm)	W (kg)
SV0300iS7-2	300	570	265.2	29.5

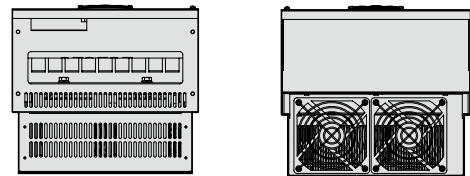

### SV0370 ~ 0450iS7 (200V)

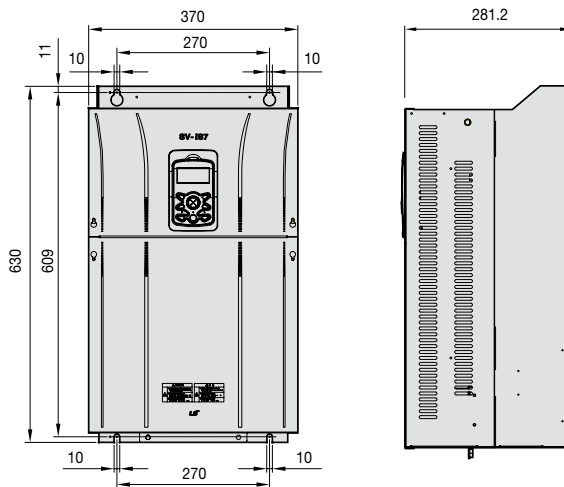

Applied inverters	W (mm)	H (mm)	D (mm)	W (kg)
SV0370iS7-2	370	630	281.2	44
SV0450iS7-2				

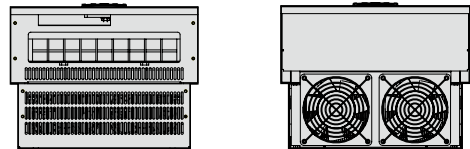

### SV0550 ~ 0750iS7 (200V)

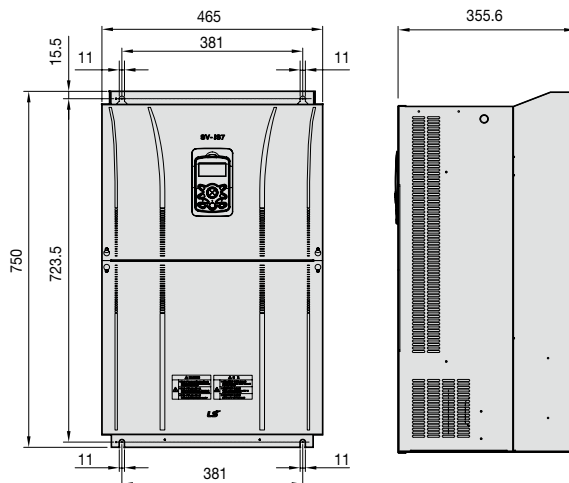

Applied inverters	W (mm)	H (mm)	D (mm)	W (kg)
SV0550iS7-2	465	750	355.6	72.5
SV0750iS7-2				

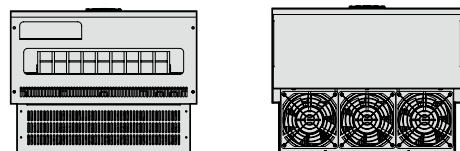



## Dimensions

### SV0300 ~ 0450iS7 (400V)

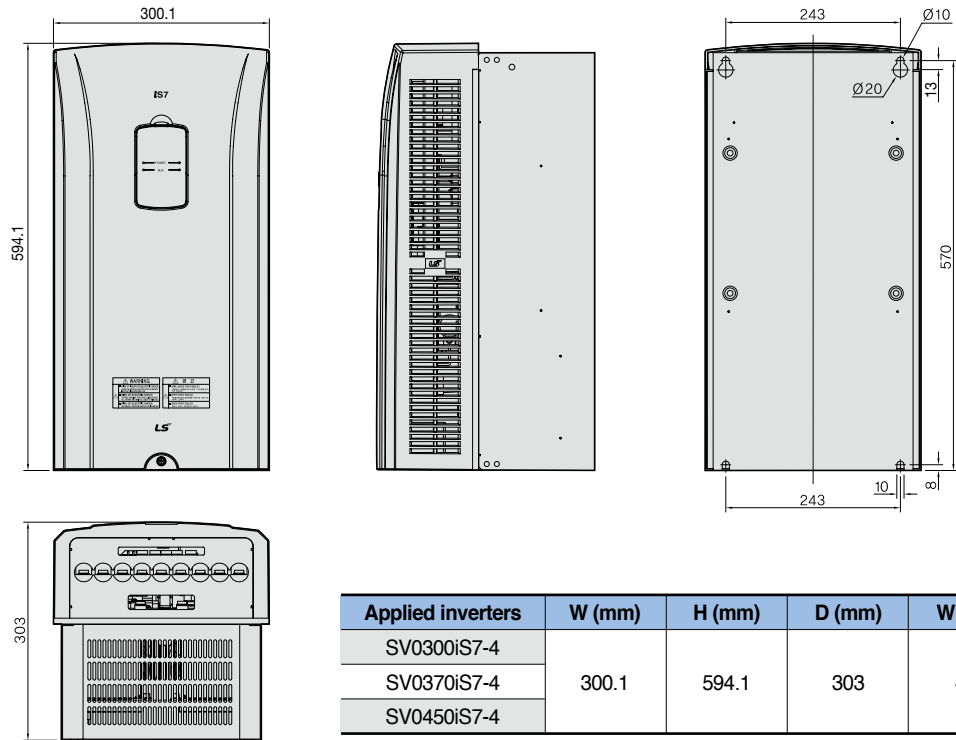

### SV0550 ~ 0750iS7 (400V)

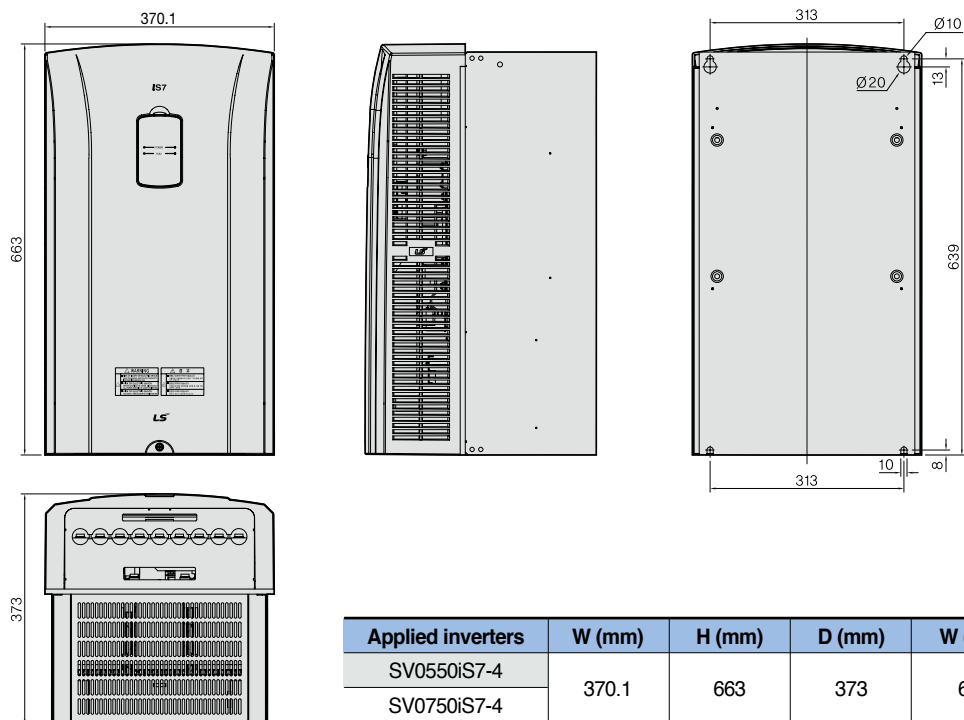



## Dimensions

### SV0900 ~ 1100iS7 (400V)

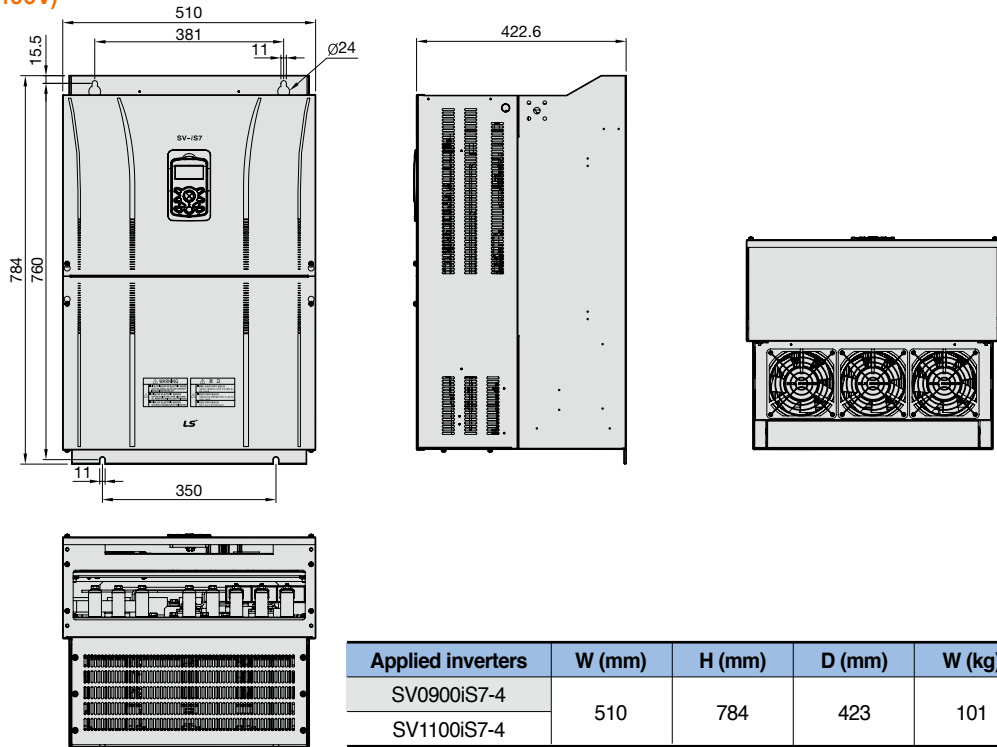

### SV1320 ~ 1600iS7 (400V)

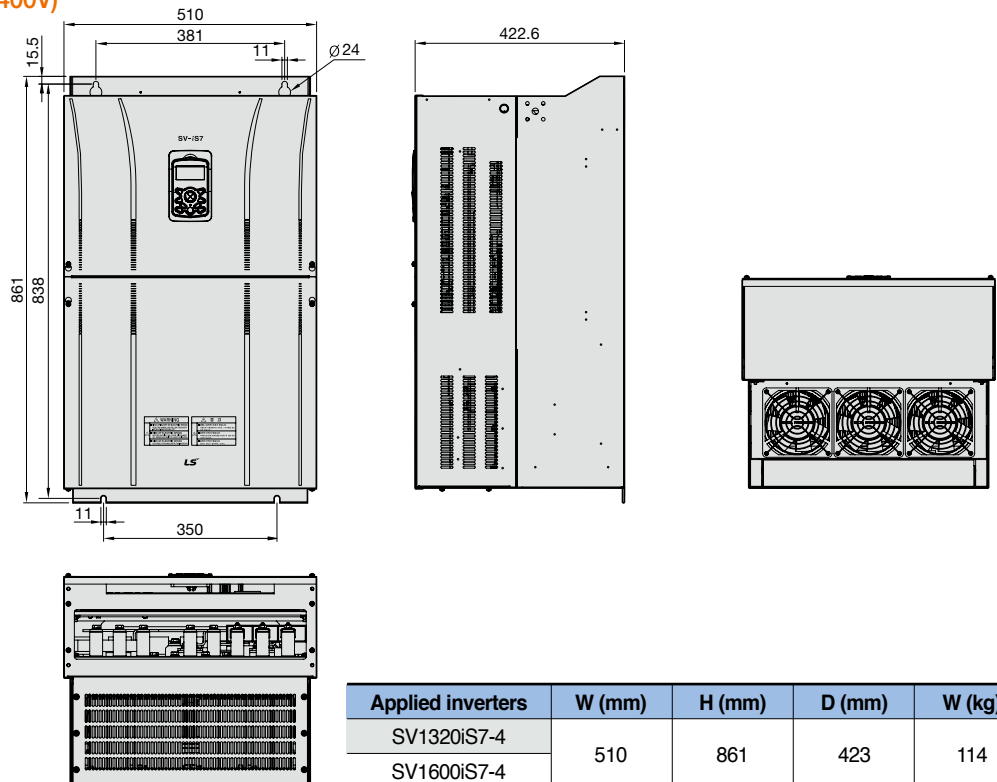

## Dimensions

### SV1850 ~ SV2200iS7 (400V)

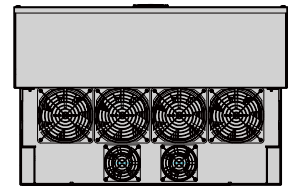
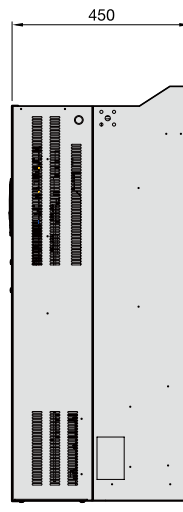
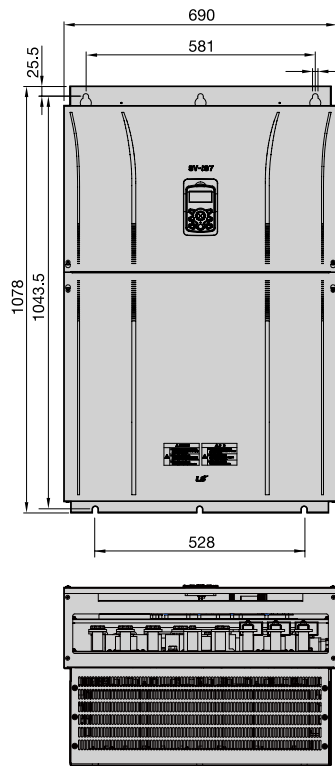

Applied inverters	W (mm)	H (mm)	D (mm)	W (kg)
SV1850iS7-4	690	1078	450	200
SV2200iS7-4				

### SV2800iS7 (400V)

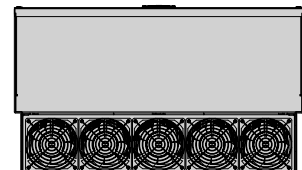
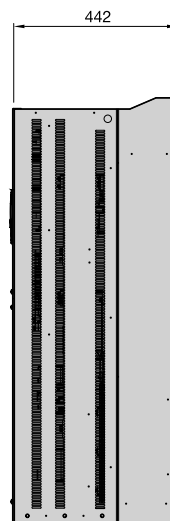
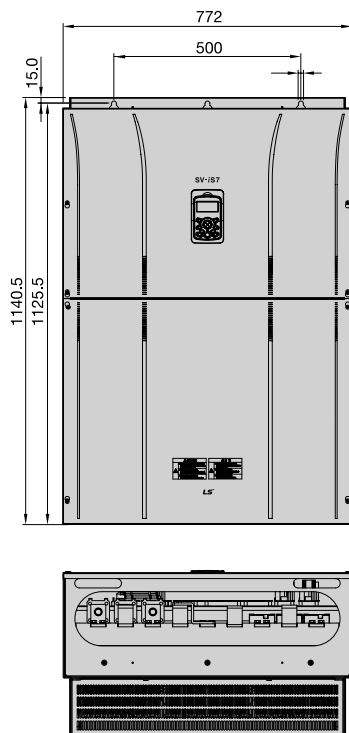

Applied inverters	W (mm)	H (mm)	D (mm)	W (kg)
SV2800iS7-4	771	1138	440	252



## Dimensions

### SV3150 ~ 3750iS7 (400V)

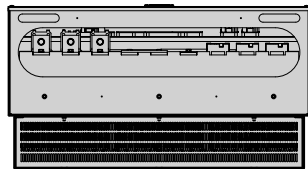
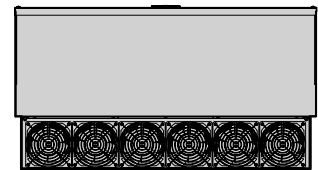
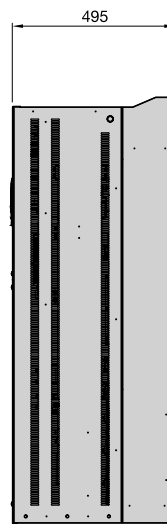
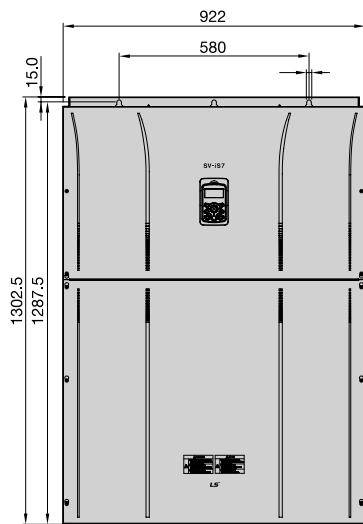

Applied inverters	W (mm)	H (mm)	D (mm)	W (kg)
SV3150iS7-4	922	1302.5	495	352
SV3750iS7-4				

## Dimensions (IP54)

### SV0008 ~ 0037iS7 (200V/400V)

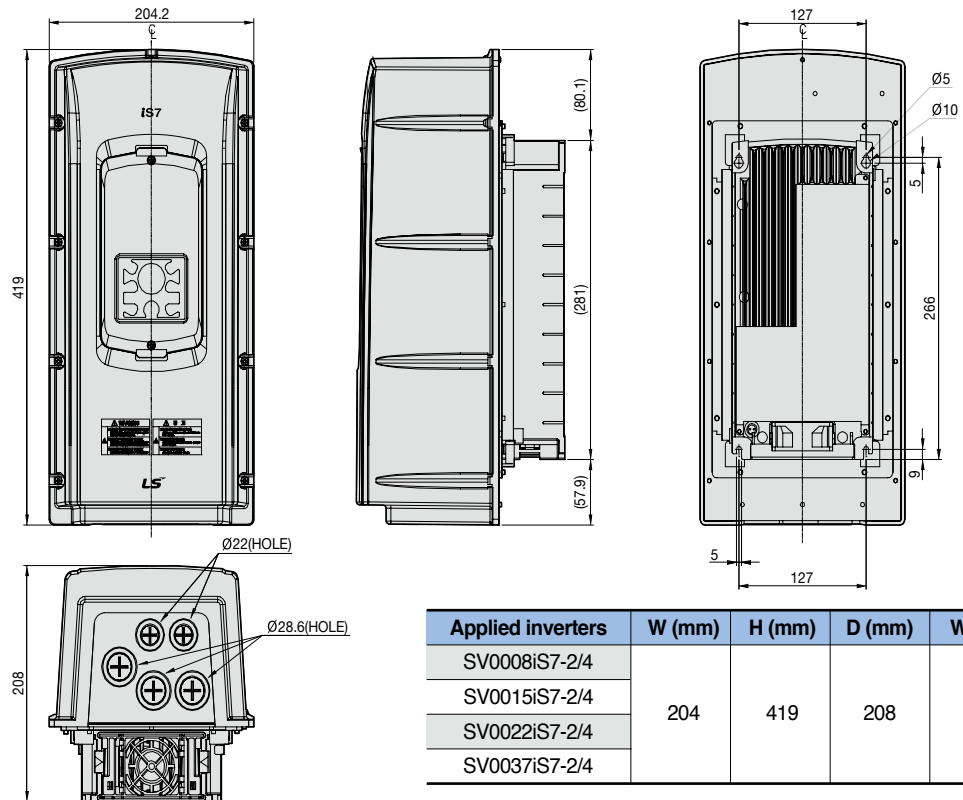

### SV0055 ~ 0075iS7 (200V/400V)

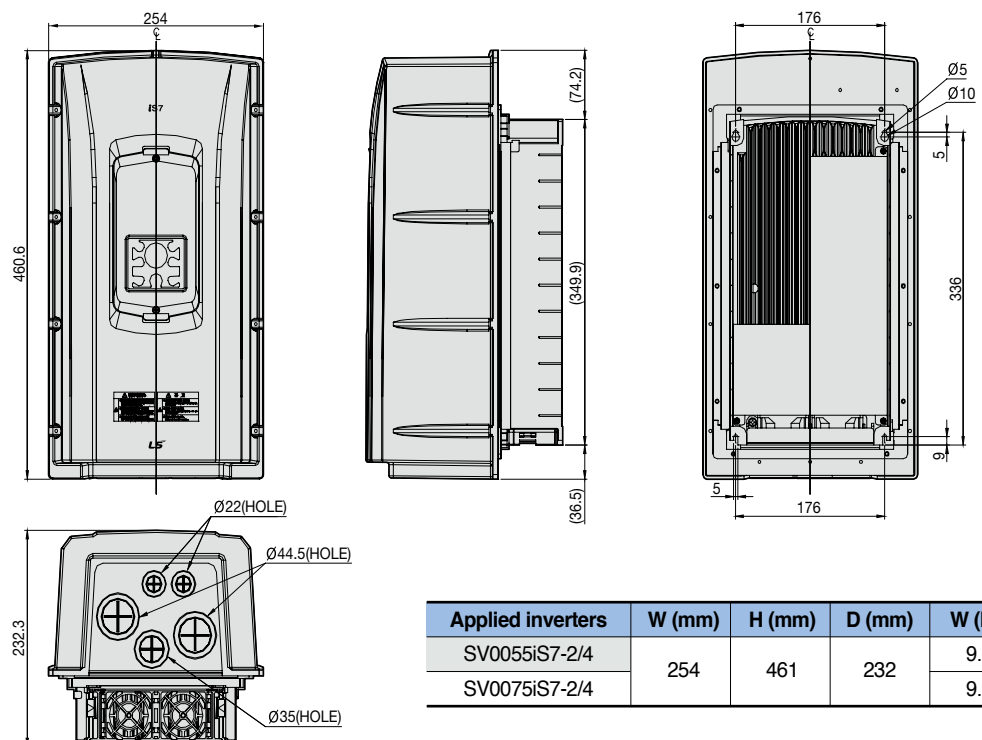



## Dimensions (IP54)

### SV0110 ~ 0150iS7 (200V/400V)

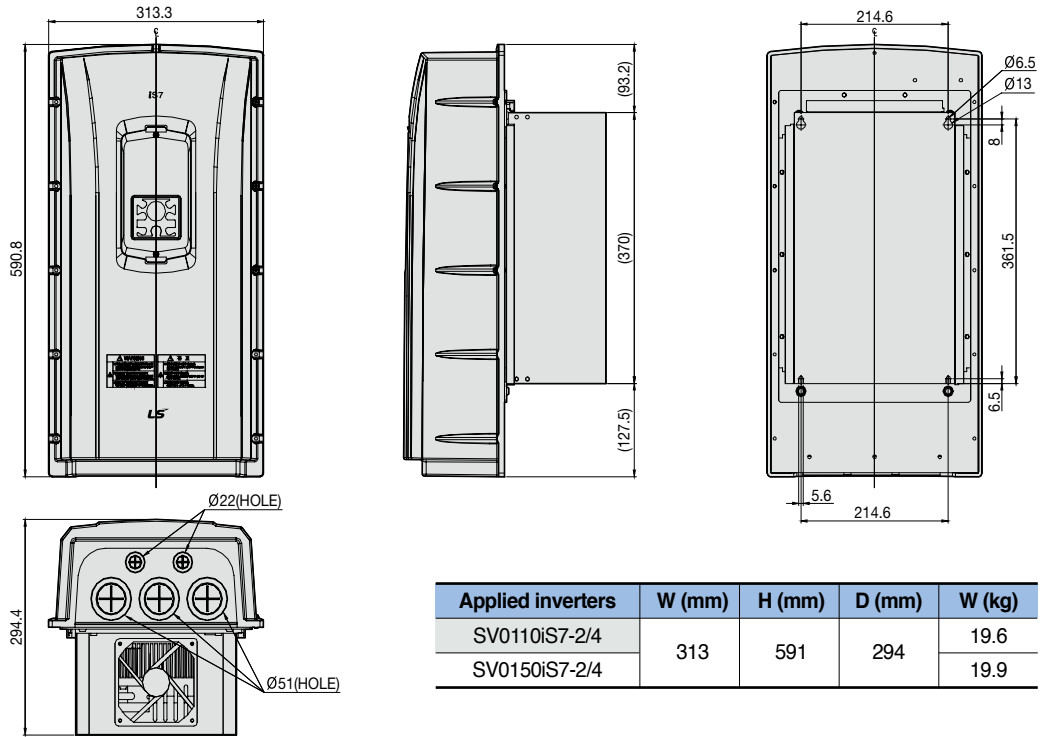

### SV0185 ~ 0220iS7 (200V/400V)

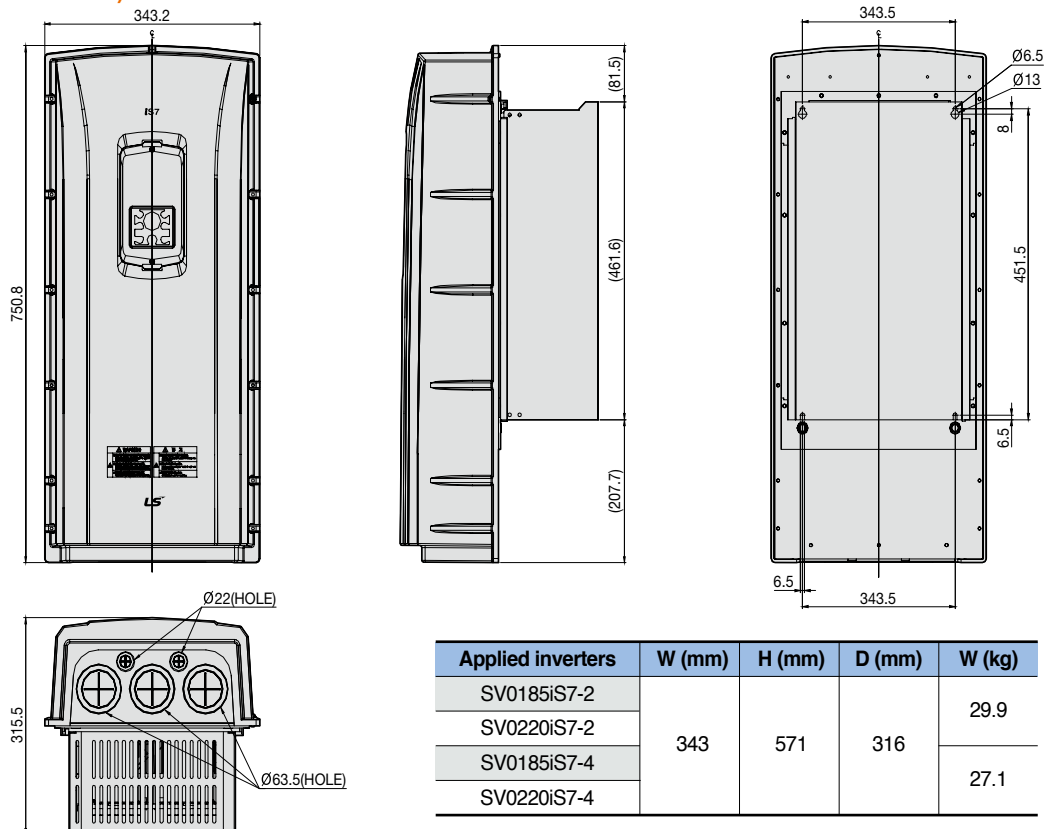

**Memo**



## Green Innovators of Innovation



### Safety Instructions

- For your safety, please read user's manual thoroughly before operating.
- Contact the nearest authorized service facility for examination, repair, or adjustment.
- Please contact a qualified service technician when you need maintenance. Do not disassemble or repair by yourself!
- Any maintenance and inspection shall be performed by the personnel having expertise concerned.

## LSIS Co., Ltd.

© 2008.2 LSIS Co.,Ltd. All rights reserved.

[www.lsis.biz](http://www.lsis.biz)

### ■ HEAD OFFICE

LS Tower, 127, LS-ro, Hogue-dong, Dongan-gu, Anyang-si,  
Gyeonggi-do 431-848, Korea

- EMEA +82-2-2034-4901 / bonseongk@lsis.biz
- Asia Pacific +82-2-2034-4620 / mswoo@lsis.biz

### ■ Global Network

- **LSIS (Middle East) FZE >> Dubai, U.A.E.**  
Address: LOB 19 JAFZA VIEW TOWER Room 205, Jebel Ali Freezone P.O. Box 114216, Dubai, United Arab Emirates  
Tel: 971-4-886 5360 Fax: 971-4-886-5361 e-mail: jungyongl@lsis.biz
- **Dalian LSIS Co., Ltd. >> Dalian, China**  
Address: No.15, Liaohexi 3-Road, Economic and Technical Development zone, Dalian 116600, China  
Tel: 86-411-8273-7777 Fax: 86-411-8730-7560 e-mail: lixk@lsis.com.cn
- **LSIS (Wuxi) Co., Ltd. >> Wuxi, China**  
Address: 102-A, National High & New Tech Industrial Development Area, Wuxi, Jiangsu, 214028, P.R.China  
Tel: 86-510-8534-6666 Fax: 86-510-522-4078 e-mail: xuhg@lsis.com.cn
- **LSIS-VINA Co., Ltd. >> Hanoi, Vietnam**  
Address: Nguyen Khe - Dong Anh - Ha Noi - Viet Nam  
Tel: 84-4-882-0222 Fax: 84-4-882-0220 e-mail: srjo@lsisvina.com
- **LSIS-VINA Co., Ltd. >> Hochiminh, Vietnam**  
Address: 41 Nguyen Thi Minh Khai Str. Yoco Bldg 4th Floor, Hochiminh City, Vietnam  
Tel: 84-8-3822-7941 Fax: 84-8-3822-7942 e-mail: sbpark@lsisvina.com
- **LSIS Tokyo Office >> Tokyo, Japan**  
Address: 16th, Higashi-Kan, Akasaka Twin Tower, 2-17-22, Akasaka, Minato-ku, Tokyo, Japan  
Tel: 81-3-3582-9128 Fax: 81-3-3582-2667 e-mail: jschuna@lsis.biz
- **LSIS Shanghai Office >> Shanghai, China**  
Address: Room E-G, 12th Floor Huamin Empire Plaza, No.726, West Yan'an Road Shanghai 200050, P.R. China  
Tel: 86-21-5237-9977 (609) Fax: 89-21-5237-7191 e-mail: jinhk@lsis.com.cn
- **LSIS Beijing Office >> Beijing, China**  
Address: B-Tower 17FL Beijing Global Trade Center B/D. No.36, BeiSanHuanDong-Lu, DongCheng-District, Beijing 100013, P.R. China  
Tel: 86-10-5825-6025,7 Fax: 86-10-5825-6026 e-mail: cuixiaorong@lsis.com.cn
- **LSIS Guangzhou Office >> Guangzhou, China**  
Address: Room 1403,14F,New Poly Tower,2 Zhongshan Liu Road,Guangzhou, P.R. China  
Tel: 86-20-8326-6764 Fax: 86-20-8326-6287 e-mail: linsz@lsis.biz
- **LSIS Chengdu Office >> Chengdu, China**  
Address: Room 1701 17Floor, huanminhanjun international Building, No1 Fuxing Road Chengdu, 610041, P.R. China  
Tel: 86-28-8670-3101 Fax: 86-28-8670-3203 e-mail: yanggf@lsis.com.cn
- **LSIS Qingdao Office >> Qingdao, China**  
Address: 7B40,Haixin Guangchang Shenye Building B, No.9, Shandong Road Qingdao 26600, P.R. China  
Tel: 86-532-8501-6568 Fax: 86-532-583-3793 e-mail: lirj@lsis.com.cn



Specifications in this catalog are subject to change without notice due to continuous product development and improvement.