

The right choice for the ultimate yield!

LS ELECTRIC strives to maximize your profits in gratitude for choosing us as your partner.

## Human Machine Interface

# XGT PANEL

iXP2 Series

User Manual



### Safety Instructions

- Read this manual carefully before installing, wiring, operating, servicing or inspecting this equipment.
- Keep this manual within easy reach for quick reference.

**LS**ELECTRIC



### Before using the product...

To use the product safely and effectively, please read this instruction manual thoroughly before use.

- ▶ Please keep to the safety precaution, for it to prevent accidents and potential danger from occurring.
- ▶ Safety precaution is classified into 'Warning' and 'Caution' and their meanings are as follows.

 **Warning** Violating the instruction may result in serious personal injury or death.

 **Caution** Violating the instruction may result in slight personal injury or product damage.

- ▶ The indicated illustrations on the product and in the manual have the following meanings.
  -  Be cautions, for danger may be present.
  -  Be cautions, for there is a possibility of an electric shock.
- ▶ After reading the instruction manual, keep it handy for quick reference.

## Design Precautions



### Warning

- ▶ **Install a safety circuit external to the HMI to protect the whole control system in case of external power supply trouble.**

Serious trouble may occur to the entire system due to erroneous output/operation of the HMI.

## Design Precautions



### Caution

- ▶ **In/output signal or communication cable should be at least 100mm apart from High-voltage/power wires.**

Otherwise, it may cause erroneous output/operation.

## Installation Precautions



### Caution

- ▶ **Use the HMI in an environment that meets the general specification contained in this manual or datasheet.**

Otherwise, it could result in electric shock, fire, erroneous operation or deterioration.

- ▶ **In case of much vibration in the installed environment, be sure to insulate the HMI from direct vibration.**

Otherwise, it could result in electric shock, fire, erroneous operation.

- ▶ **Be sure not to let foreign substances such as conductive debris inside the product.**

Otherwise, it could result in electric shock, fire, erroneous operation.

- ▶ **Do not touch the conductive part of the HMI. It may cause an electric shock, which may cause malfunction.**

## Wiring Precautions



### Warning

- ▶ **Be sure to turn off the HMI and external power before wiring.**  
Otherwise, it may result in an electric shock or damage to the product.



### Caution

- ▶ **Wire correctly by checking each of the product's rated voltage and terminal layout.**  
Otherwise, it may result in fire, electric shock or erroneous operation.
- ▶ **Tighten terminal screws with specified torque when wiring.**  
If terminal screws are loose, it may result in short circuits, fire or erroneous operation.
- ▶ **Use the exclusive HMI 3-type grounding for the FG terminal.**  
If not grounded, it may result in erroneous operation.
- ▶ **Be sure not to let any foreign substances such as wiring debris inside the module.**  
Such debris may cause fire, damage or erroneous operation.
- ▶ **Tighten the crimp terminal to the specified torque, and crimp the external connection connector using the specified tool or solder it correctly.**

## Startup and Maintenance Precautions



### Warning

- ▶ **Do not touch the terminals while power is on.**  
Otherwise, it may cause electric shock or erroneous operation.
- ▶ **Turn off the HMI and external power when cleaning or tightening the terminal.**  
Otherwise, it may cause electric shock or erroneous operation.
- ▶ **Do not charge, disassemble, heat, short circuit, solder, etc. other battery.**  
Mishandling the battery may cause overheating, crack, fire and may result in injury or fire.



### Caution

- ▶ **Do not disassemble PCB from the product case or modify the product.**  
Otherwise, it may result in fire, electric shock or erroneous operation.
- ▶ **When mounting or removing the HMI from the panel, be sure to shut off all power being used by the system. It may cause electric shock, malfunction.**
- ▶ **Use cellular phone or walky-talky at least 30cm away from the HMI.**  
Otherwise, it may result in erroneous operation.

## Disposal Precaution



### Caution

- ▶ **When disposing of this product or battery, treat it as industrial waste.**  
Otherwise, it may cause poisonous pollution or explosion.

# Revision History

Version	Date	Contents	Revised Location
V1.0	'18.01	First Edition	-
V1.1	'18.08	Add explosion-proof	<ol style="list-style-type: none"> <li>1. General Instruction</li> <li>2. System configuration</li> <li>3. Standard Specification</li> <li>4. Installation and Wiring</li> <li>6. Backup file by using storage</li> <li>7. Maintenance</li> </ol>
V1.2	'19.11	Add features and fix errors	<ol style="list-style-type: none"> <li>3. Standard Specification</li> <li>4. Installation and Wiring</li> <li>5. XGT Panel Menu Explanation</li> <li>9. Appendix</li> </ol>
V1.3	'20.04	Revision due to the change of company name	
V1.4	'20.09	Change of Touch Setting menu contents Change storage device function name	<ol style="list-style-type: none"> <li>5. XGT Panel Menu Explanation</li> <li>7. storage function</li> </ol>

※ The number of User's manual is indicated the right side of the back cover.

© LS ELECTRIC Co., Ltd 2018 All Rights Reserved.

**Chapter 1 General Introduction ..... 1-1~1-6**

1.1 How to use the Instruction Manual..... 1-1  
 1.2 Feature ..... 1-2  
 1.3 Terminology ..... 1-5  
 1.4 Specification of product name..... 1-6

**Chapter 2 System Configuration..... 2-1~2-4**

2.1 Part Names ..... 2-1  
 2.2 System Configuration..... 2-4

**Chapter 3 Standard Specification..... 3-1~3-4**

3.1 General Standards ..... 3-1  
 3.2 Function Standards ..... 3-3

**Chapter 4 Installation and Wiring ..... 4-1~4-9**

4.1 Installation ..... 4-1  
     4.1.1 Installation environment..... 4-1  
     4.1.2 Notice in handling..... 4-3  
     4.1.3 Precautions for panel installation ..... 4-3  
 4.2 Wiring ..... 4-6  
     4.2.1 Power Wiring ..... 4-6  
     4.2.2 Ground Wiring ..... 4-9

**Chapter 5 XGT Panel Menu Explanation ..... 5-1~5-39**

5.1 Settings..... 5-3  
     5.1.1 Backlight Setting ..... 5-3  
     5.1.2 Touch Setting ..... 5-5  
     5.1.3 DateTime Setting ..... 5-8  
     5.1.4 Environment Setting ..... 5-9  
     5.1.5 Ethernet Setting ..... 5-18  
     5.1.6 Buzzer Setting ..... 5-19  
     5.1.7 Sound Setting..... 5-20  
     5.1.8 XP-Remote Setting ..... 5-21  
 5.2 Diagnostics..... 5-22  
     5.2.1 Screen Diagnostic ..... 5-23  
     5.2.2 Touch Diagnostic ..... 5-24  
     5.2.3 Backup Memory Diagnostic ..... 5-25

5.2.4 Flash Memory Diagnostic.....	5-26
5.2.5 USB Memory Diagnostic.....	5-27
5.2.6 Serial Diagnostic.....	5-28
5.2.7 SD Card Diagnostic.....	5-27
5.2.8 Touch Sensitivity.....	5-30
5.3 PLC Information.....	5-33
5.3.1 PLC Communication Setting.....	5-34
5.3.2 Connection Information.....	5-35
5.3.3 PLC Information.....	5-36
5.3.4 History of PLC error.....	5-36
5.3.5 PLC Operation Mode Conversion History.....	5-37
5.3.6 History of power off of PLC.....	5-37
5.3.7 PLC System History Information.....	5-38
5.3.8 N:1 Setting.....	5-39
5.3.9 Program Monitor.....	5-40
5.4 XGT Panel Update.....	5-41
5.5 Storage Function.....	5-42
5.5.1 Overview.....	5-42
5.5.2 Project Download [Project (USB/SD -> HMI)].....	5-44
5.5.3 Project Upload [Project (HMI -> USB/SD)].....	5-45
5.5.4 Project Upload Project File(.XPD) (HMI -> USB/SD).....	5-46
5.5.5 Updating the device using a storage device.....	5-47
5.5.6 Storage device selection function [Select USB].....	5-48
5.5.7 Storage device selection function during monitoring.....	5-49

<b>Chapter 6 Backup files by using Storage Devices ..... 6-1~6-7</b>
--

6.1 Path Structure in case of File Backup.....	6-1
6.2 Operation Setting when there is no space for Backup.....	6-5
6.3 Monitoring Connection Status of External Storage Equipment.....	6-6

<b>Chapter 7 Maintenance ..... 7-1~7-3</b>
--

7.1 Maintenance.....	7-1
7.2 Daily Maintenance.....	7-1
7.3 Periodical Maintenance.....	7-2

<b>Chapter 8 EMC Standard Certification ..... 8-1~8-3</b>
---

8.1 Requirement for EMC Standard Certification.....	8-1
8.1.1 CE Standard Certification.....	8-1
8.1.2 KC Standard Certification.....	8-2
8.2 Requirement for Low Voltage Command Suitability.....	8-2
8.2.1 Standard Certification for XGT Panel.....	8-2
8.2.2 Selection of XGT Panel.....	8-2



**Appendix 1 Troubleshooting ..... App1-1~App1-25**

1. Type of Problems.....	App 1-1
2. Problems when Starting.....	App 1-2
3. Problems after the Monitor on.....	App 1-4
4. Display Problems of Figure and Object .....	App 1-6
5. Communication Problems.....	App 1-9
6. USB Removal of Memory Card.....	App 1-11
7. External memory recognition.....	App 1-12
8. Touch recognition.....	App 1-12
9. Error Message during Execution of Programs.....	App 1-13

**Appendix 2 Dimensions ..... App 2-1~App2-4**

1. iXP2-08xxA/D.....	App 2-1
2. iXP2-10xxA/D.....	App 2-2
3. iXP2-12xxA/D.....	App 2-3
4. iXP2-15xxA/D.....	App 2-4

**Appendix 3 Warranty and Environmental Policy ..... App 3-1**

1. Warranty contents.....	App 3-1
2. Environmental Policy.....	App 3-1

# Chapter 1 Overview

## 1.1 How to use the Instruction manual

Sequence	Item	Contents
Chapter1	Overview	It describes and provides information about this manual.
Chapter2	System Configuration	It describes features and system configurations for each XGT Panel.
Chapter 3	Performance Specifications	It describes XGT Panel and system configuration for each XGT Panel.
Chapter4	Installation and Wiring	It describes the installation, wiring and precautions for reliability of the PLC system.
Chapter 5	XGT Panel Menu Explanation	It describes the XGT Panel Menu.
Chapter 6	Backup files by using storage devices	It describes the way to backup recipes, logging and other files by using storage devices.
Chapter 7	Maintenance	It describes inspection categories and methods for long-term normal operation of the HMI system.
Chapter 8	EMC Standard Certification	It describes the system configuration for EMC standards.
Appendix 1	Troubleshooting	It describes a variety of error contents and measures.
Appendix 2	Dimensions	It describes the dimensions of the XGT Panel.
Appendix 3	Warranty and environment policy	-

### Notes

This manual does not explain XP-Builder or PLC connections. Please refer to the related manual for these functions.

## 1.2 Features

The XGT Panel has the following features.

- (1) Various types of external interfaces
  - (a) Supports various USB devices, Ethernet, and maximizes the customer's usability.
  - (b) Connect devices such as PLC · Inverter communication in a variety of ways.
    - RS-232C, RS-422/485 and Ethernet (10Base-T / 100Base-TX / 1000-Base-T) communication with the control device.
- (2) Based on Windows CE
  - (a) Adopted Microsoft Company's WEC 7
    - Windows Embedded Compact 7 has been used.
  - (b) Windows Embedded Compact 7 Features
    - It provides stable software capacity by using Microsoft's platform.
    - It can process diverse functions simultaneously.
    - It provides diverse interfaces including Ethernet and USB.
    - User interfaces including mouse and keyboard can be connected.
    - It has high flexibility like computer software.
    - Fast reactions are available when adding new equipment.
    - Wide data sharing and management with upper systems is available.
- (3) Projects can be sent in various ways
  - (a) Project transmission using RS-232C communication
  - (b) Project transmission using Ethernet port
  - (c) Project transfer using USB Loader cable
  - (d) Project transmission using USB memory

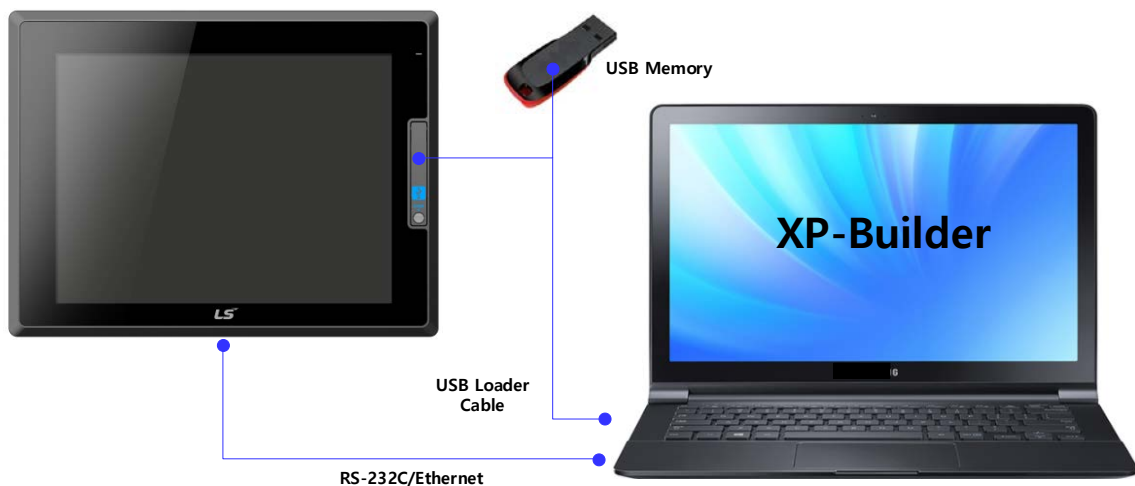

- (4) Providing a high-quality screen
  - (a) It adopts high-performance liquid crystal display (LCD) to provide high picture quality and sharpness.
    - It adopts thin film transistor liquid crystal display (TFT LCD) which can display 24bit color. Supports various graphic formats.
    - Supports 1024 X 768 graphic formats precisely and with realistic representation.
    - Supports behavior for animations (GIF).
  - (c) Supports external display output.
    - HDMI output is supported.
    - Duplicate mode and extended mode enable screen output in various configurations.

- (5) Application of Projective CAP touch panel
  - (a) Touch sensitivity is improved by applying electrostatic touch panel.
  - (b) Multi-touch and gesture functions.
  - (c) Various types of touch setting functions can be used according to user's work environment.
- (6) Provides multilingual support and various fonts
  - (a) Supports multi-language languages.
    - It uses the method of transferring the window / user font used on the computer to XGT Panel.
    - No separate multilingual language development is required.
    - Multilingual language support is an advantage of Windows CE.
  - (b) Supports simultaneous display of 12 languages.
    - Simultaneous display in 12 languages
    - Even when the XGT Panel is in operation, you can switch to another language by using special switches.
  - (c) Various fonts are provided.
    - Windows / user fonts can be used, so various expressions are possible.
    - You can freely adjust font size and shape.



### (7) Providing various convenience functions

#### (a) Various alarm functions are provided.

- The history alarm can be divided into several alarm groups and alarm lists. The desired alarm can be displayed on the screen with the alarm explorer.
- The flow alarm displays the current alarm at the bottom of the screen.
- The system alarm is displayed when a critical problem occurs during operation.

#### (b) It provides a logging function.

- It provides periodic logging that works repeatedly according to the time and device status and conditional logging according to device conditions.
- Backup provides up to 1 Mbyte.
- You can backup to a USB.
- Backup data is stored in Excel format, so you can use it conveniently.

#### (c) It provides a recipe function.

- It provides read / write function.
- One recipe provides up to 100 double words (DWORD), 16 blocks.
- You can backup to a USB.
- Backup data is stored in Excel format, so you can use it conveniently.

#### (d) It provides a scheduler function.

- Up to 32 schedulers can be set.

#### (e) It provides a printing function.

- Screen / alarm printing function.
- Print out the printout.

#### (f) It provides scripting capabilities.







- User-written scripts provide more flexibility.
- Global / Object / Screen display.

### (8) Stable products conforming to international standards

#### (a) CE, KC (Electromagnetic compatibility registration) standard acquisition

## 1.3 Terminology

It describes terms used in this manual.

Term	Definition	Note
Module	A standard element that has a specified function which configures the system. Devices such as I/O board, which are inserted onto the mother board or base unit.	Ex) CPU module Power Module I/O module
PLC system	System consisted of PLC and peripheral device which can be controlled by user program.	-
XP-Builder	Software used to write and edit the project.	-
XP-Manager	Software that can be configured to communicate between XGT Panel	-
XP-Remote	Software used to remote monitor and control the XGT Panel	-
Cnet module	Computer Link	-
FEnet module	Fast Ethernet Network	-
RTC	Abbreviation of Real Time Clock, It is used to call general IC that contains the clock function.	-
AC voltage	Voltages whose charge flow and direction change periodically with time	
Ground	Electrical device with a connecting ground wire in to keep the electric potential of the device to zero	
Electric shock	The current flows in the human body, causing injury or shock.	
Caution	Failure to observe the instructions may cause dangerous situations that may result in <b><u>serious injury or damage</u></b> to property or property damage.	 Caution
Warning	Failure to observe the instructions may cause dangerous situations that may result in <b><u>death or serious injury.</u></b>	 Warning
Caution mark	As a general precaution, when you need to observe the instructions given in the user's manual	

## 1.4 Product Name Rule

It describes terms used in this product's names.

iXP2 -   
           ↓      ↓      ↓      ↓      ↓  
       (A)  (B) (C) (D) (E)

Menu	Sign	Contents	Note
(A) LCD size	08	21cm (8.4")	-
	10	26 cm (10.2")	-
	12	31cm (12.1")	-
	15	38 cm (15.0)	-
(B) O/S type	0	WinCE 7.0 (Core)	-
	1	WinCE 7.0 (Pro)	
(C) Communication support	0	Standard type	395 x 294 x 485 Ethernet(10 Base-T/100 Base-TX, 10 Base-T/100 Base-TX/1000 Base-T)
(D) Power	A	AC 100 ~ 240V	-
	D	AC 19.2 ~ 28.8V	-
(E) Extension code	EXP	Export product	-
	Ex	Explosion proof product	-

## Chapter 2 System Configuration

Characteristic of each iXP2 series and its system configuration are as follow;

### 2.1 Part Names

#### 1. iXP2-08xxA/D, 10xxA/D, 12xxA/D, 15xxA/D

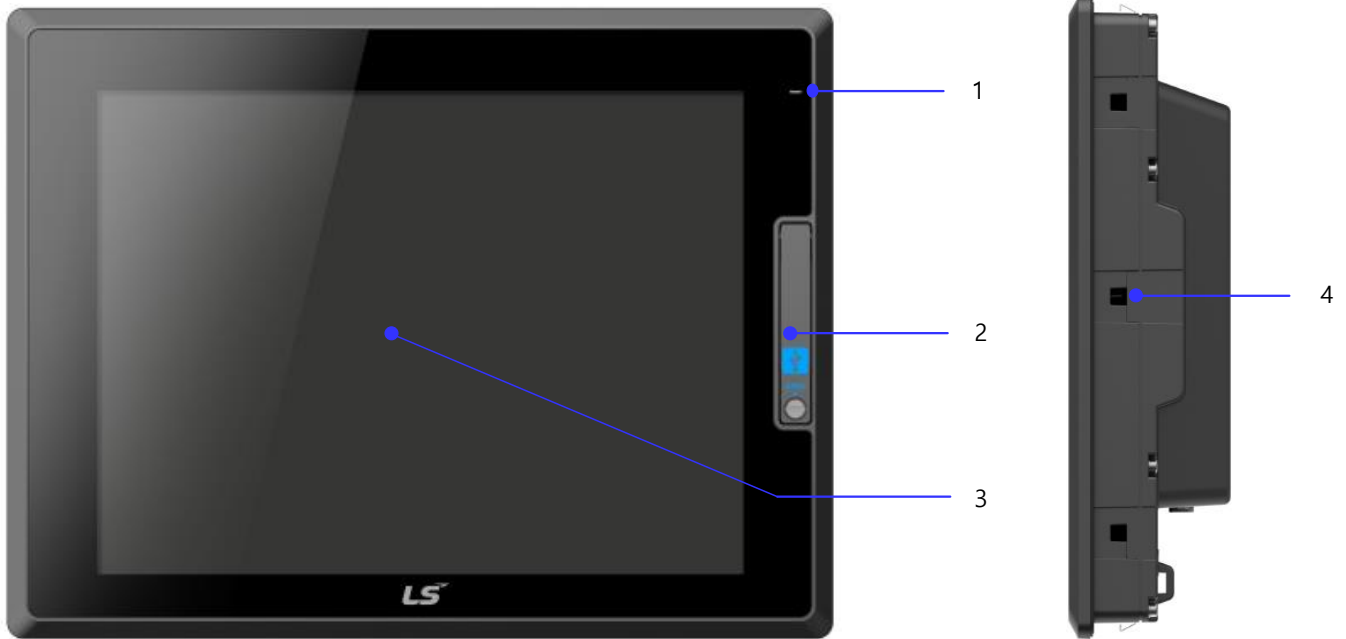

No.	Name	Function
1	Power LED	1) Display the power status of the device ※ Display using high brightness blue LED
2	Front USB	1) USB Host 1ch 2) USB Device 1ch
3	Front Part	1) P-CAP touch panel: User touch input 2) LCD: Display
4	Panel fixing portion	1) Fix ing XGT Panel to Panel with Bracket



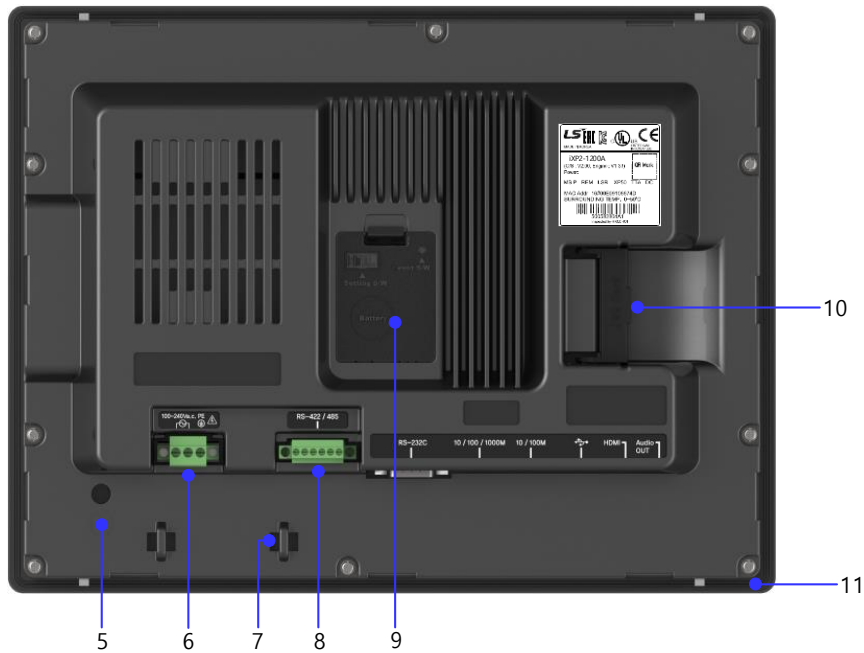

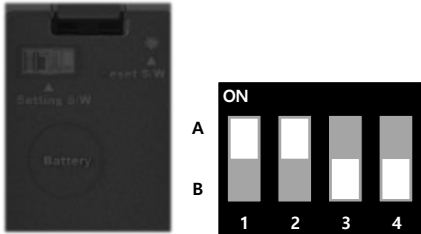
No.	Name	Function															
5	PE connector	PE connection															
6	Power Connector	Power and PE connections															
7	Cable fixing hole	Fixing Cables															
8	RS-422/485 connector	RS-422/485 (COM3): PLC / Control device communication															
9	Battery cover, Reset switch, Backup battery, Setting switch	 <p>&lt;Setting switch&gt;</p> <table border="1"> <tbody> <tr> <td rowspan="2">No. 1/2</td> <td>A Side.</td> <td>RS-422/485 termination resistance On (Default)</td> </tr> <tr> <td>B Side.</td> <td>RS-422/485 termination resistance Off</td> </tr> <tr> <td rowspan="2">No. 3</td> <td>A Side.</td> <td>O/S Download</td> </tr> <tr> <td>B Side.</td> <td>Nand Flash booting(Default)</td> </tr> <tr> <td rowspan="2">No. 4</td> <td>A Side.</td> <td>Backup Battery On</td> </tr> <tr> <td>B Side.</td> <td>Backup Battery Off(Default)</td> </tr> </tbody> </table> <p>&lt;Reset S/W&gt; System reset switch. Pressing the switch will reset the system.</p>	No. 1/2	A Side.	RS-422/485 termination resistance On (Default)	B Side.	RS-422/485 termination resistance Off	No. 3	A Side.	O/S Download	B Side.	Nand Flash booting(Default)	No. 4	A Side.	Backup Battery On	B Side.	Backup Battery Off(Default)
No. 1/2	A Side.	RS-422/485 termination resistance On (Default)															
	B Side.	RS-422/485 termination resistance Off															
No. 3	A Side.	O/S Download															
	B Side.	Nand Flash booting(Default)															
No. 4	A Side.	Backup Battery On															
	B Side.	Backup Battery Off(Default)															
10	SD Card	Logging / Recipe / Alarm / Project data backup and transfer															
11	Gasket	Protecting from water and dust															

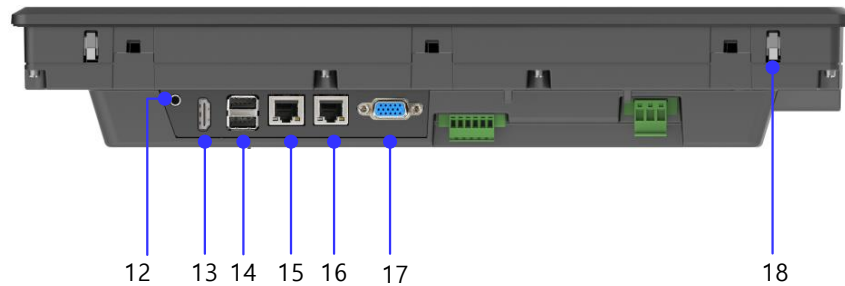

No.	Name	Function
12	Audio-Out	Stereo audio output
13	HDMI	Clone mode display output
14	USB host	1) USB memory connection: Logging / Recipe / Alarm / Project data Backup and transfer 2) User Interface Connection: Use mouse / Keyboard 3) Printer connection: Print function
15	Ethernet terminal	Ethernet: 10Base-T / 100Base-TX 1) Project data transmission 2) Logging / Recipe / Alarm / Screen Data Backup 3) Upgrading the device software 4) PLC / control device communication
16	Ethernet terminal	Ethernet: 10Base-T / 100Base-TX / 1000Base-T 1) Project data transmission 2) Logging / Recipe / Alarm / Screen Data Backup 3) Upgrading the device software 4) PLC / control device communication
17	RS-232C connector	RS-232C (COM2): PLC / Control device communication
18	Anti-drop lock	Thanks to anti-drop lock, the Panel can be installed in a panel by a single operator.

### Note

- (1) The surface of the touch panel must be kept clean at all times.
  - Foreign objects (water, oil, etc.) on the touch panel may cause malfunction.
- (2) Touching the front of the touch panel may cause malfunction.
  - Be careful that conductive objects do not touch the touch panel.
- (3) The switch No. 1/2 of the setting switch must be set in the same direction.
  - If switches 1 and 2 are set in different directions, communication problems may occur.
- (4) Refer to the communication manual for details on communication connection.
- (5) Please refer to Chapter 10 for installation details.
- (6) For explosion-proof products
  - Can open front USB cover using star wrench
  - Front USB can only be used as a maintenance function

## 2.2 System Configuration

To use XGT Panel, you must create project data in XP-Builder and transfer it to XGT Panel.

By default, you can connect to XGT Panel using USB.

Basically, it can be connected with XGT Panel using RS-232C method.  
The maximum communication speed is 115,200 [bps].

With Ethernet, project data can be transferred quickly.  
If the LAN environment is established as shown below, you can use it more easily and effectively.

1: 1 connection is also supported in case LAN (LAN) environment is not established.

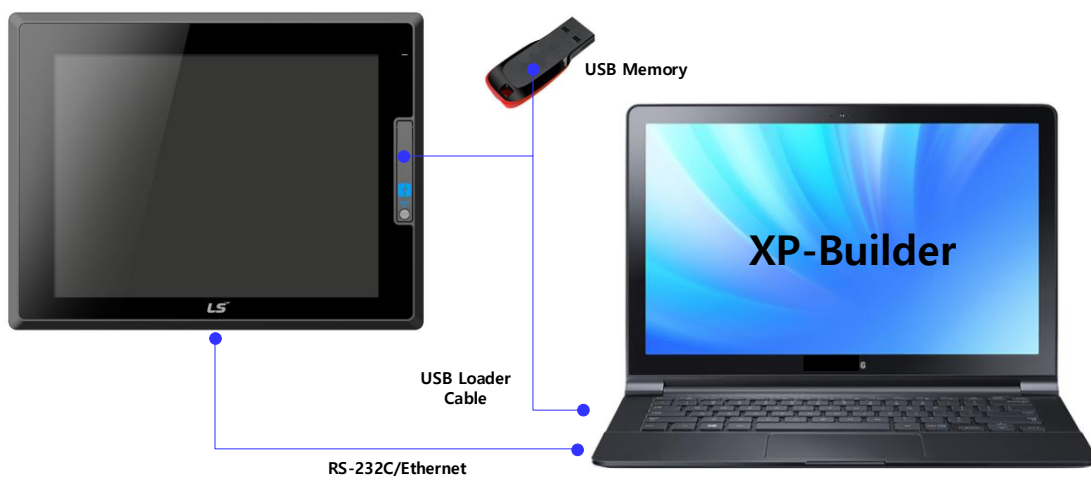

If project data can not be transferred using communication, you can transfer data using USB storage device or SD card.  
Please refer to Chapter 5 and XP-Builder User's Guide for more information.

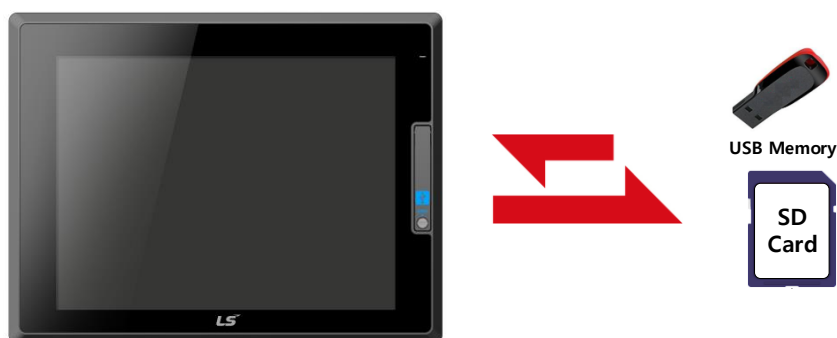

### Note

- (1) It is recommended to use Ethernet rather than RS-232C.
- (2) Refer to the communication manual for how to make the Ethernet cable.
- (3) Refer to XP-Builder manual for project transfer method.

## Chapter 3 Standard Specification

### 3.1 General Standards

General specifications of XGT Panel are as follows.

No.	Item	standard	Related Standards			
1	Ambient temperature	0 °C ~ +50 °C	-			
2	Storage temperature	-20 °C ~ +60 °C	-			
3	Operating humidity	10 ~ 85%RH, non-condensing.	-			
4	Storage humidity	10 ~ 85%RH, non-condensing.	-			
5	Vibration resistance	Occasional vibration			Count  10 times each in X, Y and Z direction	IEC 61131-2
		frequency	acceleration	amplitude		
		5≤f<9 Hz	-	3.5mm		
		9≤f≤150 Hz	9.8m/s <sup>2</sup>	-		
		Continuous vibration				
		frequency	acceleration	amplitude		
		5≤f< 9 Hz	-	1.75mm		
		9≤f≤150 Hz	4.9m/s <sup>2</sup>	-		
6	Shock endurance	* Maximum shock acceleration: 147m/s <sup>2</sup> (15G) * Duration time: 11ms * Pulse wave: half sine pulse (3 times each in X, Y and Z directions)	IEC 61131-2			
7	Noise Immunity	Square wave Impulse noise	AC: ±1,500V DC: ±1,000V	LS ELECTRIC		
		Electrostatic Discharge Immunity	±4 kV (contact discharge), ±8 kV (air discharge)		IEC 61131-2 IEC 61000-4-2	
		Electromagnetic Radiated Emissions	80 ~ 1,000 MHz, 10 V/m		IEC 61131-2 IEC 61000-4-3	
		Fast Transient /Burst noise	Category	Power module	Communication interface	IEC 61131-2 IEC 61000-4-4
			Voltage	2 kV		
		Surge	Category	AC power	DC power supply	Communication interface
Voltage	2kV (LG) 1 kV (LL)		1kV (LG) 0.5 kV (LL)	1 kV		
8	Environment	Free from corrosive gases and excessive dust		-		
9	Operating height	Below 2,000m (6,562ft)		-		
10	Pollution degree	2 or less		-		
11	Cooling method	Natural Air-Cooling		-		

### Note

(1) IEC(International Electro technical Commission)

- International private group facilitating international cooperation of electric/electronic standardization, issuing international standards and operating the compliance evaluation systems.

(2) Pollution degree

- As an index representing the pollution degree of an environment to determine the insulation of a device, pollution degree 2 generally means the status generating non-conductive contamination. However, it also contains the status generating temporarily conduction due to condensation.

(3) Noise Immunity

- The noise standard is the standard of the HMI body and the operation of the video display device connected to HDMI is not guaranteed.

## 3.2 Function Standards

The functional specifications of XGT Panel are as follows.

(1) Normal Type

Item	iXP2-08xxA/D	iXP2-10xxA/D	iXP2-12xxA/D	iXP2-15xxA/D
Display type	TFT color LCD			
Screen size	8.4 "	10.4 "	12.1 "	15 "
Display resolution	800 x 600	1024 x 768		
Color indication	24-bit color (16.7M colors)			
Indication degree	Right and left: 80 deg. Top: 80 deg. Bottom: 60 deg.	Right: 75 deg. Top: 75 deg. Bottom: 75 deg.	Right and left: 80 deg. Top: 80 deg. Bottom: 80 deg.	
Backlight	LED method, automatic On / Off support			
Backlight lifetime	50,000 hour			
Touch panel	Capacitive Touch			
Audio output	Magnetic Buzzer (85dB)			
Processor	1GHz, Dual core			
Memory	Drawing Memory	128Mbyte		
	Operating RAM	1GB		
	Backup RAM	1 Mbyte		
Backup data	Date / Time data, Logging / Alarm / Recipe data, Non-volatile devices			
Battery	CR2032(3.0V/210mAh, About 3years/25℃)			
Video Output	1 x HDMI			
Audio Out	3.5Φ x 1, 40mW			
Ethernet	1 x 10Base-T / 100Base-TX, 1 x 10Base-T / 100Base-TX / 1000Base-T			
USB host	3 x USB 2.0 (Front x 1, Rear x 2)			
USB device	1 x USB 2.0 (Send / Receive front, PC and project data etc.)			
RS-232C	1 x RS-232C (DSUB 9 / Male type)			
RS-422/485	1 x RS-422/485 (Terminal Block)			
Multi-language	Can display 12 languages simultaneously			
Animation	GIF format support			
Recipe	Support			
Data logging	Support			
Script Launcher	Support			
Standard Certification	CE, KC, UL			
Protection standard	IP66(Front)			
Dimensions (mm)	240 × 180 × 60	271 × 212 × 60	313 × 239 × 60	395 × 294 × 66
Panel Cut (mm)	228.5 × 158.5	259.0 × 201.0	301.5 × 227.5	383.5 × 282.5
Power	A(AC100~240V), D(DC19.2~28.8V)			
Power consumption (W)	25	25	30	30
Weight (Kg)	1.87	2.35	3.0	4.6

(2) Special Type

Item	iXP2-08xxA/D-EX	iXP2-10xxA/D-EX	iXP2-12xxA/D-EX	iXP2-15xxA/D-EX
Display type	TFT color LCD			
Screen size	8.4 "	10.4 "	12.1 "	15 "
Display resolution	800 x 600	1024 x 768		
Color indication	24-bit color (16.7M colors)			
Indication degree	Right and left: 80 deg. Top: 80 deg. Bottom: 60 deg.	Right: 75 deg. Top: 75 deg. Bottom: 75 deg.	Right and left: 80 deg. Top: 80 deg. Bottom: 80 deg.	
Backlight	LED method, automatic On / Off support			
Backlight lifetime	50,000 hour			
Touch panel	Capacitive Touch			
Audio output	Magnetic Buzzer (85dB)			
Processor	1GHz, Dual core			
Memory	Flash	1GB		
	Operating RAM	1GB		
	Backup RAM	1 Mbyte		
Backup data	Date / Time data, Logging / Alarm / Recipe data, Non-volatile devices			
Battery	CR2032(3.0V/210mAh, About 3years/25 °C)			
Video Output	1 x HDMI			
Audio Out	3.5Φ x 1, 40mW			
Ethernet	1 x 10Base-T / 100Base-TX, 1 x 10Base-T / 100Base-TX / 1000Base-T			
USB host	3 x USB 2.0 (Front x 1, Rear x 2)			
USB device	1 x USB 2.0 (Send / Receive front, PC and project data etc.)			
RS-232C	1 x RS-232C (DSUB 9 / Male type)			
RS-422/485	1 x RS-422/485 (Terminal Block)			
Multi-language	Can display 12 languages simultaneously			
Animation	GIF format support			
Recipe	Support			
Data logging	Support			
Script Launcher	Support			
Standard Certification	CE, KC, UL, IECEx, ATEX, KCs			
Protection standard	Ex nA IIC T5 Gc, Ex tc IIIC T100 °C Dc IP64			
Dimensions (mm)	240 x 180 x 60	271 x 212 x 60	313 x 239 x 60	395 x 294 x 66
Panel Cut (mm)	228.5 x 158.5	259.0 x 201.0	301.5 x 227.5	383.5 x 282.5
Power	A(AC100~240V), D(DC19.2~28.8V)			
Power consumption (W)	25	25	30	30
Weight (Kg)	1.87	2.35	3.0	4.6
Specific conditions of use	<ol style="list-style-type: none"> <li>The equipment presents a potential electrostatic hazard. Clean only with a damp cloth.</li> <li>The device for nA marked equipment shall be installed in an enclosure that maintains and ingress protection rating of at least IP4X where there are bare live parts and the equipment is intended for installation only in locations providing adequate protection against the entry of solid foreign objects or water capable of impairing safety. The device for tc marked equipment shall be installed in an enclosure IP64 in accordance with IEC 60079-31.</li> <li>Must be installed in accordance with EN 60079-14.</li> <li>Do not connect or separate plugs and sockets while an explosive atmosphere is present.</li> </ol>			

Item	iXP2-08xxA/D-EX	iXP2-10xxA/D-EX	iXP2-12xxA/D-EX	iXP2-15xxA/D-EX
	5. Keep out of direct sunlight			

### Note

- (1) Caution in power connection
  - With AC power applied to DC power device, it may cause product damage or fire. Please pay a special attention to connection.
- (2) PE Connection
  - For the device PE, please use PE terminal.
- (3) Battery discharge-prevention DIP switch
  - In order to prevent the battery discharge, turn off the DIP switch No.4.  
To use backup function, please turn on DIP switch No. 4.
- (4) Battery Operation and Life
  - Battery is used for RTC (date/time) when the power of device is off. Battery is not consumed with power applied.
- (5) LCD Backlight Replacement
  - Please replace LCD if you want to replace LCD backlight.
- (6) Protection standard
  - XGT Panel is designed by IP66 Standard in front parts. Ingress Protection (IP) is based on the IEC 60529 Standard for degrees of protection provided by enclosures. But XGT Panel does not guarantee from all installation environment. When installing panels, make sure that dust and moisture are not brought in. For more details on installation, See Chapter 4.Installation and Wiring.
  - It complies with the following specifications.
    - IEC 60079-0:2011
    - EN 60079-0:2011
    - IEC 60079-15:2010
    - EN 60079-15:2010
    - IEC 60079-31:2013
    - EN 60079-31:2013



### 3.3 Cable Standards

#### 3.3.1 UTP Cable

UTP cables are categorized into two types with the following standards..

- ① Shield type: Three types (UTP, FTP, STP)
- ② Seven types of frequency bands used 7 types (Cat.1-7)

(1) Cable types (shields)

Type	Details	Purpose
UTP(or U.UTP)	Unshielded cable for fast signals	Max 200 MHz Audio + Data + Low video signals
FTP(or S.UTP)	Cable shielding cable cores only	Max 100 MHz Considers EMI and electric stabilization Audio + Data + Low video signals
STP(or S.STP)	Double layer shielding by shielding each pair and cable shielding cable cores only	Max 500 MHz Audio + Data + Video signals For replacing 75Ω coaxial cables

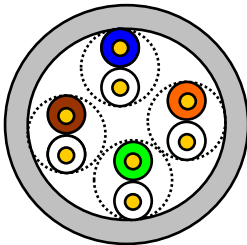

UTP

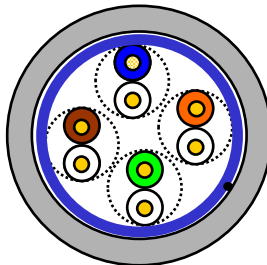

FTP

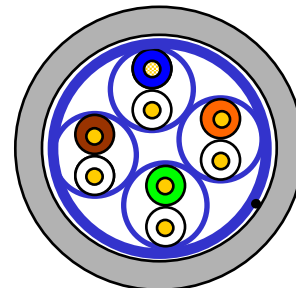

STP

**Note**

- (1) UTP: Unshielded Twisted Paired Copper Cable  
 FTP: (Overall) Foiled Twisted Paired Copper Cable  
 STP: (Overall) Shielded (and Shielded Individually Pair) Twisted Paired Copper Cable
- (2) Patch Cable (or Patch Cord)  
 For the purpose of improving the flexibility of the UTP 4-pair cables, sometimes a wired conductor is used instead of a solid conductor.  
 The target standards and materials used are Un-coated AWG 24 (7/0203A).  
 In other words, the small line diameter is 0.203 mm, the small line is standardized to 1 + 6 structure, and the material is the annealing copper wire.
- (3) For the PLC Ethernet communication cable use of the S.STP cable is recommended. If the S.STP cable cannot be used due to the environmental conditions, it may result in communication abnormalities and noise in more than one module.

(2) Type per used frequency

Type	Used frequency (MHz)	Transmission speed (Mbps)	Purpose
Category 1	Audio frequency	1	Telephone network (2Pair)
Category 2	4	4	Multi pair communications cable
Category 3	16	16	Telephone network + Computer network
Category 4	20	20	Speed up the computer network 2) Low-loss communications cable
Category 5 and Enhanced Category 5	100	100	1) Digital telephone network + Computer network 2) Low-loss, broadband cable

**Note**

(1) The categories that are commercially available in Korea and globally are categories 3, 5, En-Cat.5 and CAD.6. Category 4 is now defunct following the category 5 appearances, and category 7 is a STP structure that is in the development phase worldwide

(3) Example of category 5, UTP (CTP-LAN5)

Item	Unit		Value
Conductor resistance (Max)	$\Omega/\text{km}$		93.5
Insulation resistance (Min)	$\text{M}\Omega\cdot\text{km}$		2,500
or less voltage	V/Min		AC 500
Characteristic impedance	$\Omega$ (1-100MHz)		$100 \pm 15$
Attenuation	dB/100 m or less	10 MHz	Attenuation
		16 MHz	
		20 MHz	
Near-end crosstalk attenuation	dB/100 m or less	10 MHz	Near-end crosstalk attenuation
		16 MHz	
		20 MHz	

# Chapter 4 Installation and Wiring

## 4.1 Installation

### 4.1.1 Installation environment

This machine has high reliability regardless environment. But for reliability and stability, be careful the followings

#### (1) Environment condition

- (a) Install at the panel which can protect this machine from water and dust. XGT Panel is designed by IP66 Standard in front parts and IP20 Standard in rear parts.
- (b) Install at the place where impact and vibration is not continuously applied. XGT Panel is designed to meet IEC standard (IEC 61131-2).
- (c) Do not expose this machine to direct light.
- (d) Do not install at the place where rapid temperature change can occur. Moisture by rapid temperature change can cause malfunction and damage.
- (e) If the XGT Panel is exposed to low or severe temperature changes, dew may occur between the front panel and LCD screen. In this case, malfunction or damage of the product may occur, so wait until the surface temperature of the XGT Panel is close to the ambient temperature before turning on the power.
- (f) This machine should be installed within 0~50°C, otherwise the screen may be changed or cause malfunction.
- (g) This machine should be installed within 10~85% relative-humidity. Moisture by rapid temperature change can cause malfunction and damage.
- (h) Avoid corrosive gas and burnable gas.

#### (2) Installation construction

- (a) When doing screw's processing or wiring construction, be careful that the remains do not enter the XGT Panel inside.
- (b) Install at the place where you can easily control.
- (c) Do not install with high voltage machine within same Panel.
- (d) Keep distance of more than 100mm from duct for wiring and peripheral machine.
- (e) Ground at the place where few noises develop.

#### (3) Anti-heat design of control panel

- (a) In case of installing XGT Panel in the airtight panel, consider the heat by other machine as well as own heat. In case that the air circulates through a ventilating opening or a general pan, XGT Panel system can be influenced by in-draft of dust or gas.
- (b) We recommend you to install a filter or to use an airtight heat exchanger.

**Note**

(1) Waterproof and dustproof standard

(a) IP66 Standards

- 1) The protection standards of XGT Panel have been designed to meet the IP66 test conditions, in accordance with the degrees of protection provided by enclosures of IEC60529. As this machine installed at the panel, it is not guaranteed with all installation environment even though its protection standards for the front parts are satisfied.
- 2) IP66 rating guarantees the enclosure is dust proof (6) and protected against jets of water (6).
- 3) IP20 rating guarantees protection from solid foreign objects of above 12mm diameter proof (2), but it does not guarantee protection from water ingress.

Elemento Element	Cifre o lettere Numerals or letters	Significato per la protezione dell'apparecchiatura Meaning for the protection of equipment	Significato per la protezione delle persone Meaning for the protection of persons	Rif. Ref.
Lettere caratteristiche Code letters	IP	—	—	—
Prima cifra caratteristica First characteristic numeral	0 1 2 3 4 5 6	Contro la penetrazione di corpi solidi estranei: Against ingress of solid foreign objects: (non protetto)_(non-protected) ≥ 50 mm di diametro_≥ 50 mm diameter ≥ 12,5 mm di diametro_≥ 12,5 mm diameter ≥ 2,5 mm di diametro_≥ 2,5 mm diameter ≥ 1,0 mm di diametro_≥ 1,0 mm diameter protetto contro la polvere_dust-protected totalmente protetto contro la polvere_dust-tight	Contro l'accesso a parti pericolose con: Against access to hazardous parts with: (non protetto)_(non-protected) dorso della mano_back of hand dito_finger attrezzo_tool filo_wire filo_wire filo_wire	Art. 5 Cl. 5
Seconda cifra caratteristica Second characteristic numeral	0 1 2 3 4 5 6 7 8	Contro la penetrazione di acqua con effetti dannosi: Against ingress of water harmful effects: (non protetto)_(non-protected) caduta verticale_vertically dripping caduta di gocce d'acqua (inclinazione 15°)_dripping (15° tilted) pioggia_spraying spruzzi d'acqua_splashing getti d'acqua_jetting getti potenti_powerful jetting immersione temporanea_temporary immersion immersione continua_continuous immersion	—	Art. 6 Cl. 6
Lettera aggiuntiva (opzionale) Additional letter (optional)	A B C D	—	Contro l'accesso a parti pericolose con: Against access to hazardous parts with: dorso della mano_back of hand dito_finger attrezzo_tool filo_wire	Art. 7 Cl. 7
Lettera supplementare (opzionale) Supplementary letter (optional)	H M S W	Informazioni supplementari relative a: Supplementary information specific to: Apparecchiatura ad alta tensione High-voltage apparatus Prova con acqua con apparecchiatura in moto Motion during water test Prova con acqua con apparecchiatura non in moto Stationary during water test Condizioni atmosferiche Weather conditions	—	Art. 8 Cl. 8

(KS C IEC 60529: 2006 standard)

(b) Notice

- 1) In the environment where the protection grade of XGT Panel is exceeded or not satisfied, the damage of the device or malfunction can occur due to the failure of protecting the product.
- 2) Since the protection grade of XGT Panel is the water-proof/dust-proof standards, it cannot be protected from oil, corrosive gas and metal particles.
- 3) In case when Gasket is damaged by chemicals and continuous vibration, its water-proof/dust-proof effect can be weakened.
- 4) In case when installing the panel, make sure that dust and water are not brought in panels.

## 4.1.2 Notice in handling

This section describes the precautions for handling the XGT Panel from opening to installation.

- Do not drop or subject it to strong impacts.
- Do not open the product case or take any action. In such cases, we are not responsible for the product.
- When wiring, be careful not to let foreign substances such as wiring residue into the XGT Panel.

## 4.1.3 Precautions for panel installation

Describes how to install the XGT Panel on the panel and notes.

### (1) Panel cut

- Before installing the XGT Panel on the panel, it must be manufactured on the panel as shown in the table below.

Unit: [mm]

division	X (Horizontal)		Y (Vertical)		Z (Thickness)
iXP2-08xxA/D	228.5	+1 -0	158.5	+1 -0	1.6 to 6.0
iXP2-10xxA/D	259.0	+1 -0	201.0	+1 -0	
iXP2-12xxA/D	301.5	+1 -0	227.5	+1 -0	
iXP2-15xxA/D	383.5	+1 -0	282.5	+1 -0	

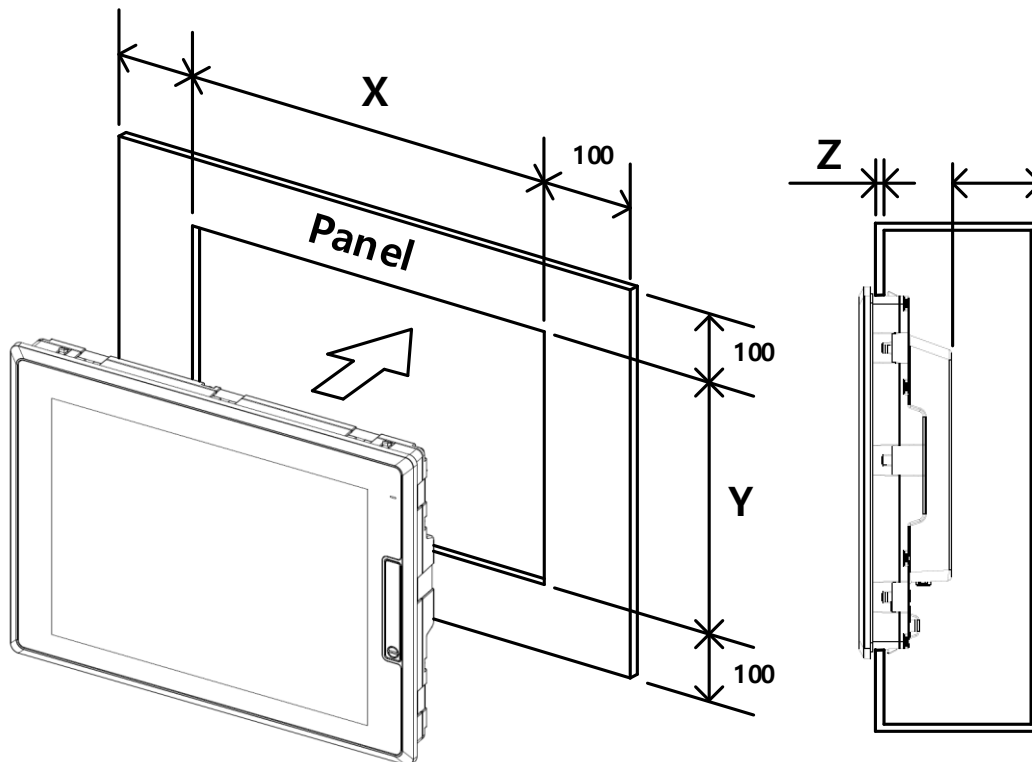

### (2) Panel installation

- When mounting the XGT Panel on the panel, please install 100mm or more in each direction.

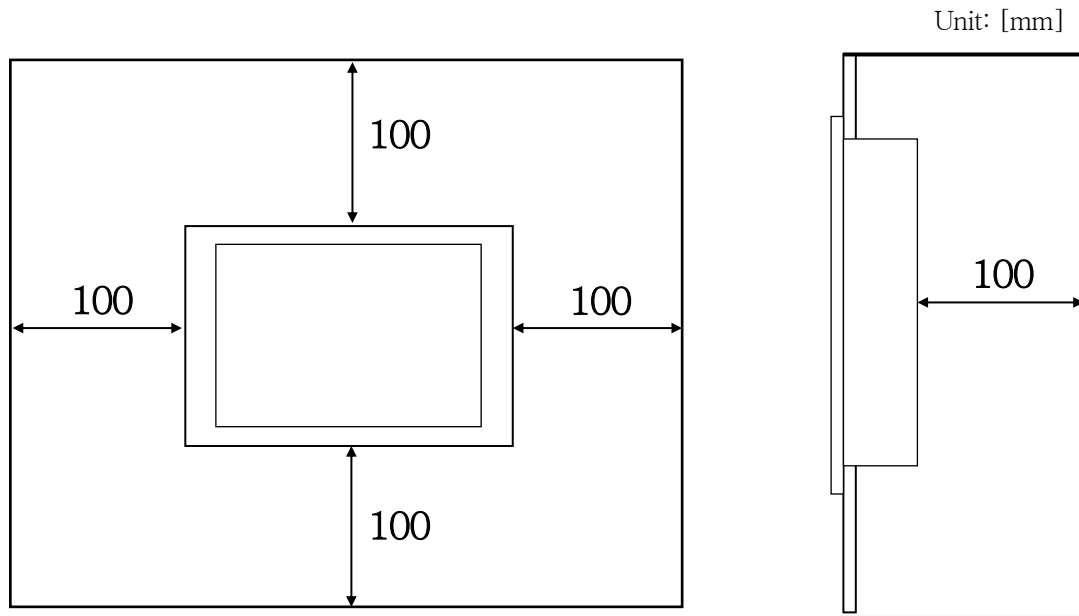

#### Note

- (1) In order to be less affected by electromagnetic waves (radiation noise) or heat generated by other control devices, Required.
- (2) Install it considering the wiring of power and communication cables.
- (3) When the panel cut dimensions are outside the reference tolerance (0 ~ + 1mm) when making the panel, the gap between the gasket and the panel. The contact area may be reduced, and the waterproof and dustproof effect may be weakened.
- (4) When mounting the product on the panel, use gasket for waterproof and dustproof. The XGT Panel basically has a waterproof and dustproof gasket is equipped.
- (5) If the surface of the panel on which the XGT Panel is mounted is uneven, there is a gap between the XGT Panel and the panel, or dust may penetrate. Particularly, depending on the material (steel, aluminum, acrylic, etc.) of the panel, This may require installation environment review. Also check that the gasket and panel are in close contact. It is absolutely necessary.
- (6) If the condition of the gasket is contaminated or damaged due to deterioration at the time of installation or after a certain period of use, the waterproof and dustproof effect care should be taken because it can be significantly weakened, and if a gasket needs to be replaced, contact your nearest dealer or service. Please contact the center.
- (7) In case of explosion-proof equipment, it should be installed in the environment with pollution degree 2 or less according to KS IEC 60664-1.
- (8) Install the front of the explosion-proof product in a place protected from the inflow of liquid in order to maintain the explosion-proof performance after installation in accordance with the requirements of the obligatory safety certificate notice of the protection device (Ministry of Employment and Labor Notice 2013-54)

- When installing the product on the panel, use gasket for waterproof and dustproof. The XGT Panel is basically equipped with a waterproof and dustproof gasket.

### (3) Installation location

- Please consider screen display and touch use for XGT Panel installation.
- If you exceed the display angle below, the screen may not be clearly visible. It is recommended to install the product considering the angle of view.

Division	Angle (left and right)	Upper	Lower
iXP2-08xxA/D	80 deg.	80 deg.	60 deg.
iXP2-10xxA/D	75 deg.	75 deg.	75 deg.
iXP2-12xxA/D	80 deg.	80 deg.	80 deg.
iXP2-15xxA/D	80 deg.	80 deg.	80 deg.

#### (4) Fixing

- Fix the XGT Panel using the brackets on the panels as shown below.  
(The bracket is included in the product.)

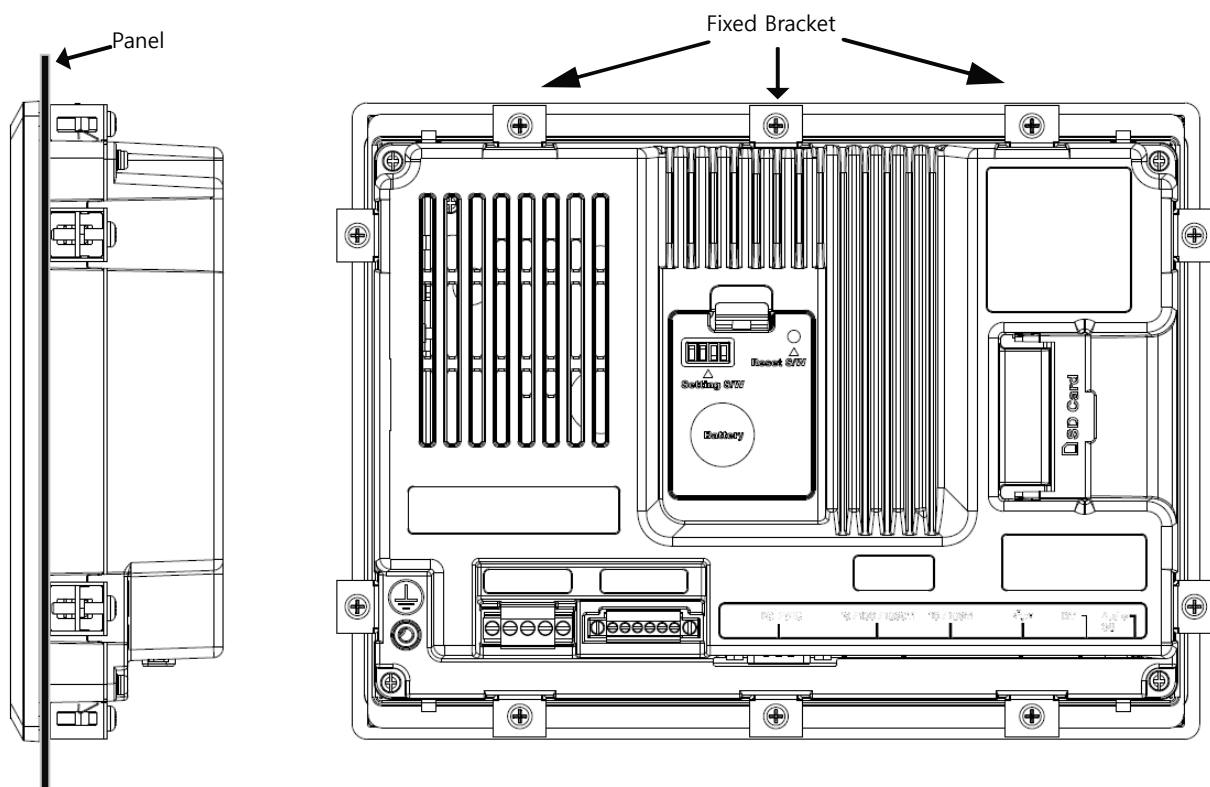

#### Note

- (1) During installation, XGT Panel should be closely contacted to the panel not to have any gap. In the environment requiring water-proof/dust-proof effect, install and fix a bracket on a slope.
- (2) The bracket should be fixed symmetrically(Up-Down, Left-Right). In case when it is not fixed symmetrically, there could be a gap between the panel and XGT Panel.
- (3) When fixing the bracket, it should be installed perpendicularly to the panel, and the required bracket screw torque is 6.7kgf · cm. Depending on the material type of the panel, the torque value can be different. The standard screw torque for each bolt size is followed. If it is fixed with the power more than the required screw torque, the touch malfunction or weakening of water-proof/dust-proof can happen due to the deformation of XGT Panel.

#### (5) Removal of protective film

- Be sure to remove the film attached to the panel to protect the front sheet when it is shipped from the factory.

### Note

- (1) Remove the protection film attached to the front of this machine. Due to the deformation of the protection film, the touch malfunction or wrong input can occur. It is recommended to use a special protection sheet to protect the front sheet. In case of purchasing the protection sheet, contact the agency or a sales office close by.

### (6) Product Separation

- Loosen the fixing bracket screw and remove the bracket from the XGT Panel.
- Press the Anti-drop lock as shown below and then slowly push it forward to remove it from the panel.

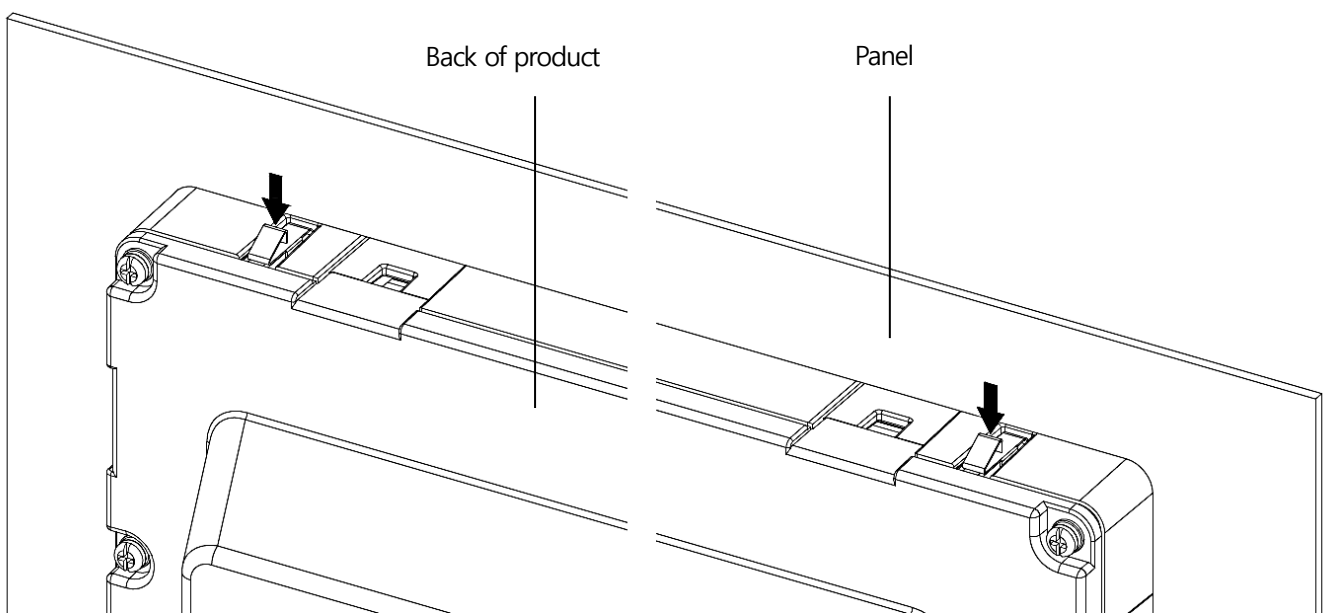

### Note

- (1) If the device is forcibly removed from the panel without anti-drop lock, the product may be damaged.
- (2) Be careful not to drop the product when removing the device from the panel.



### 4.2 Wiring

Describes the wiring matters when installing the XGT Panel.

#### 4.2.1 Power Wiring

XGT Panel is divided into DC (DC) and AC (AC) products.

power	Product Name
DC 24V	iXP2-08xxD
	iXP2-10xxD
	iXP2-12xxD
	iXP2-15xxD
AC100-240V	iXP2-08xxA
	iXP2-10xxA
	iXP2-12xxA
	iXP2-15xxA



#### Caution

- ▶ Connecting AC power to a device that uses DC power may cause product damage or fire. Be careful of connection.
- ▶ 'XXD' is a product using DC 24V and 'XXA' is a product using AC100-240. Be sure to check the polarity of the back of the product before use.
- ▶ The equipment shall be installed in an enclosure which maintains an ingress protection rating protection rating of at least IP64 and meets the enclosure requirements of IEC 60079-0 and IEC 60079-15, IEC 60079-31.
- ▶ Transient protection shall be provided that is set at a level not exceeding 140 % of the peak rated voltage value at the supply terminals to the equipment.
- ▶ The equipment shall only be used in an area of not more than pollution degree 2, as defined in IEC 60664-1.
- ▶ Plugs and sockets shall not be separated while an explosive atmosphere may be present.
- ▶ The equipment presents a potential electrostatic hazard. Clean only with a damp cloth.
- ▶ Install in a vertical direction only.

Use the following specifications for the power cable.

Type	Cable specification (Unit: mm <sup>2</sup> )	Wire Type	Thermal Resistance	Screw Torque
Power and protection ground	1.5(AWG16) ~ 2.5(AWG12)	Copper	60°C	0.51N•m

### Note

- (1) For installations where there is voltage drop, it is recommended to use stranded wire with a cross sectional area greater than 2 mm<sup>2</sup>.
- (2) It is recommended that cable connections are twisted and secure. Short cable runs are also recommended between the point of supply and the XGT panel.
- (3) For safety reasons it is recommended that you use color coded outer sheaths on the conductors to aid safe terminations.

Power connection is as shown below.

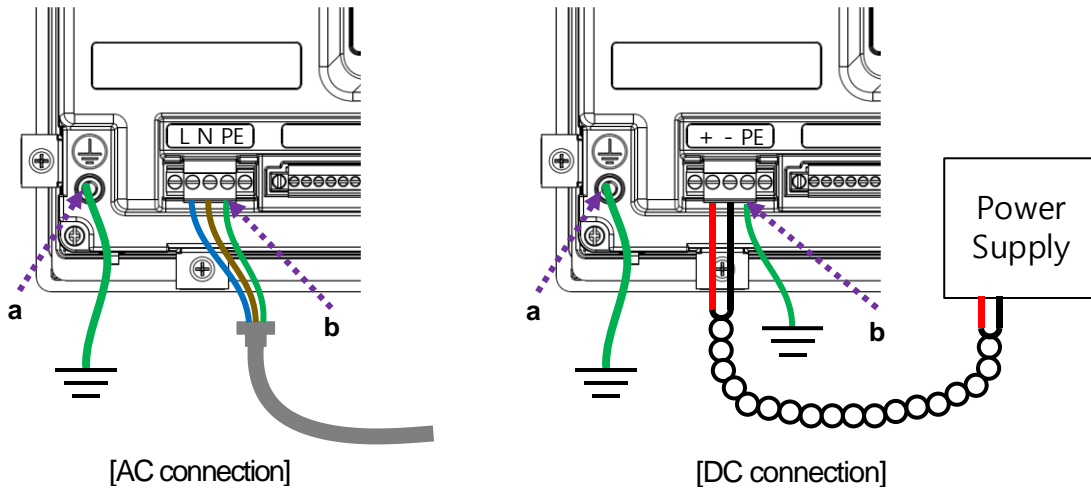

### Note

- (1) When the power fluctuation is larger than the specified value range, use a constant voltage transformer.
- (2) When there is a lot of noise in the power supply, use an insulation transformer.
- (3) Momentary power failure for stable data backup when power on / off. Please use.
- (4) "a" is external earth, "b" is internal earth.

## Chapter 4. Installation and Wiring

For XGT Panel power supply, I / O devices and power devices, separate the power supply system as shown below.

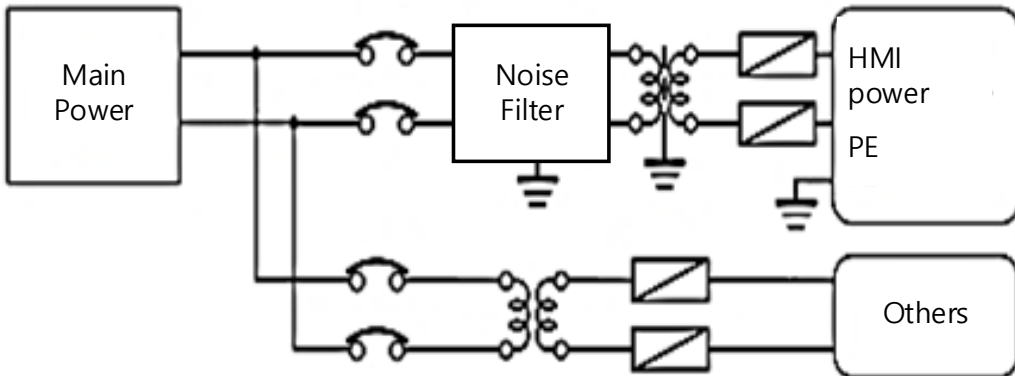

### Note

Do not bring the power line of the XGT Panel close to the main circuit (high voltage, high current) line or I / O signal line. Possible 100mm Install at an interval of more than two.

Use the surge absorber as shown in the figure below to prevent surge such as lightning.

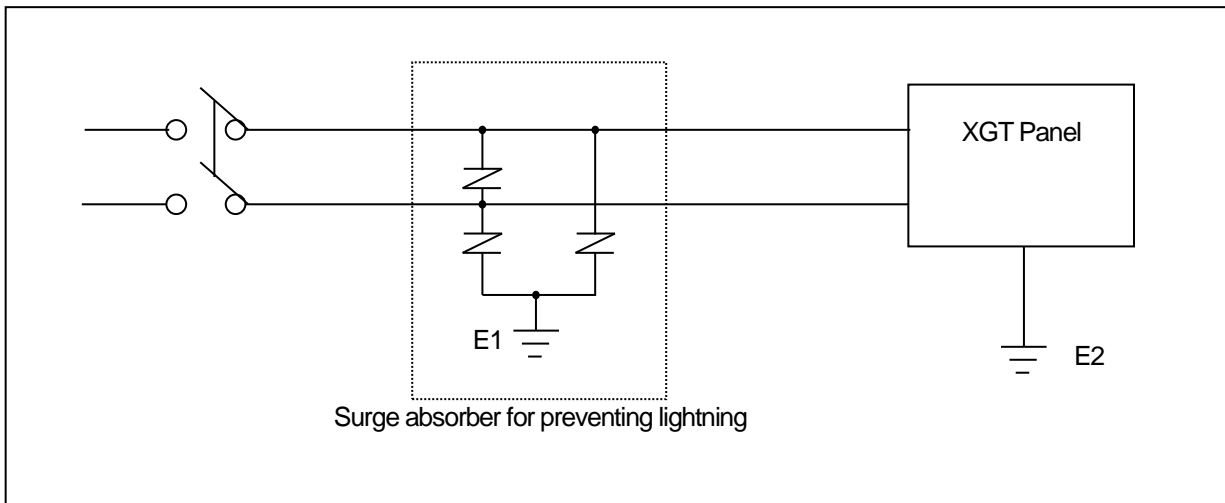

### Note

- (1) Separate grounding (E2) of the XGT Panel of ground surge absorber (E1).
- (2) Select the surge absorber so that the surge absorber does not exceed the maximum allowable voltage even when the power supply voltage rises to a maximum please give it to me.

When there is concern about noise penetration, use an insulation shield transformer or a noise filter.  
 Be sure to twist the wiring of the input power supply as short as possible and do not let the wiring of the shielding transformer or noise filter pass through the duct.

When using a magnetic contactor (MC) for AC / DC, it is recommended to use Ferrite Core at the power input terminal.

EX) Apply a ferrite core to the power terminal as shown in the figure.

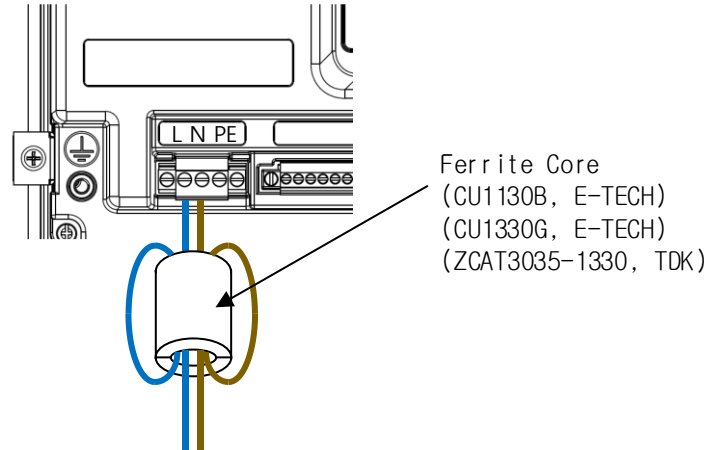

### 4.2.2 Ground Wiring

- (1) This XGT Panel has enough noise countermeasures, so it can be used without grounding except when there is a lot of noise. However, when grounding, please refer to the following.
- (2) Grounding should be done by dedicated grounding as much as possible. Grounding works are classified as class 3 grounding (grounding resistance 100 Ω Or less).
- (3) When dedicated grounding is not possible, use common ground as shown in Fig.

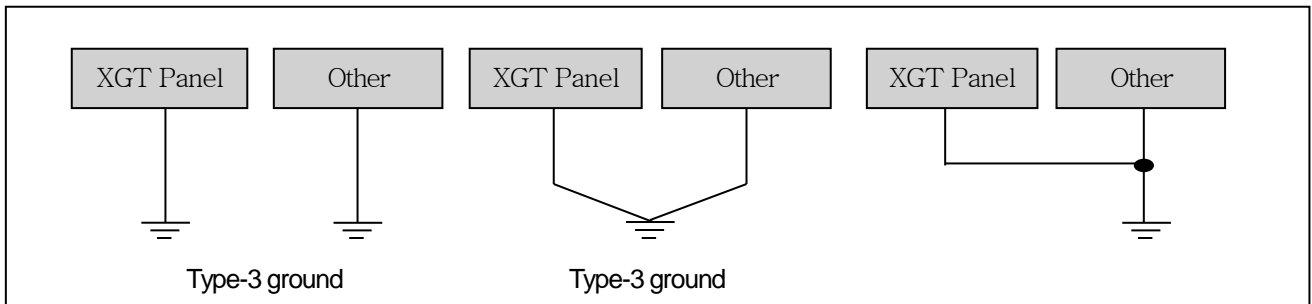

A) Exclusive ground: Best

B) Common ground: Good

C) Common ground: Bad

- (4) Ground wire is 2 mm<sup>2</sup> or more. If possible, place the grounding point near the XGT Panel to shorten the length of the ground wire.

**Note**  
 If the grounding condition is bad or connected as in (C), the XGT Panel may malfunction or communication failure may occur. Be sure to check grounding.

### 4.2.3 An external interface cable fixing

- (1) Connect the cable tie through the external interface cable fixing hole on the back of the unit.

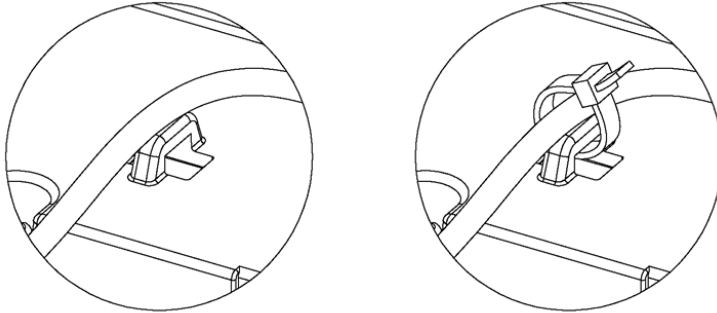

\* iXP2 – 15XX, 12XX, 10XX Series

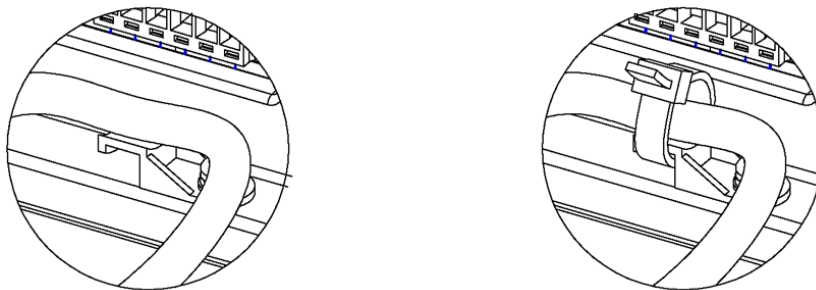

\* iXP2 – 08XX Series

- (2) Tighten the cable tie firmly so that the external interface cable does not come off by external force.

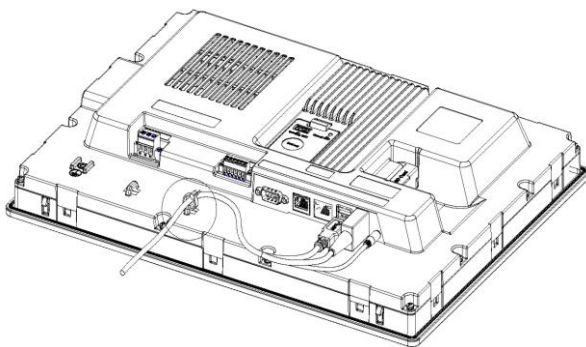

iXP2 – 15XX, 12XX, 10XX Series

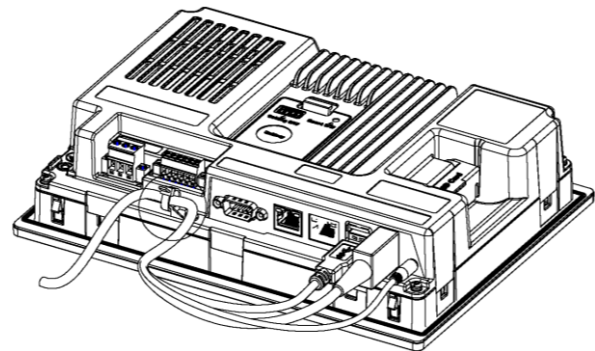

iXP2 – 08XX Series



### Caution

► External interface cable anchors are an important factor in maintaining explosion proof performance. If it is not installed as described above, it may cause explosion due to spark due to abnormal connection of cable. Therefore, please be sure to familiarize yourself with the above instructions.

## Chapter 5 XGT Panel Menu Explanation

This chapter describes how to set the environment such as XGT Panel time setting, Ethernet connection setting, backlight setting. If you press the [Settings] button on the XGT Panel main screen, you can set the environment of XGT Panel.

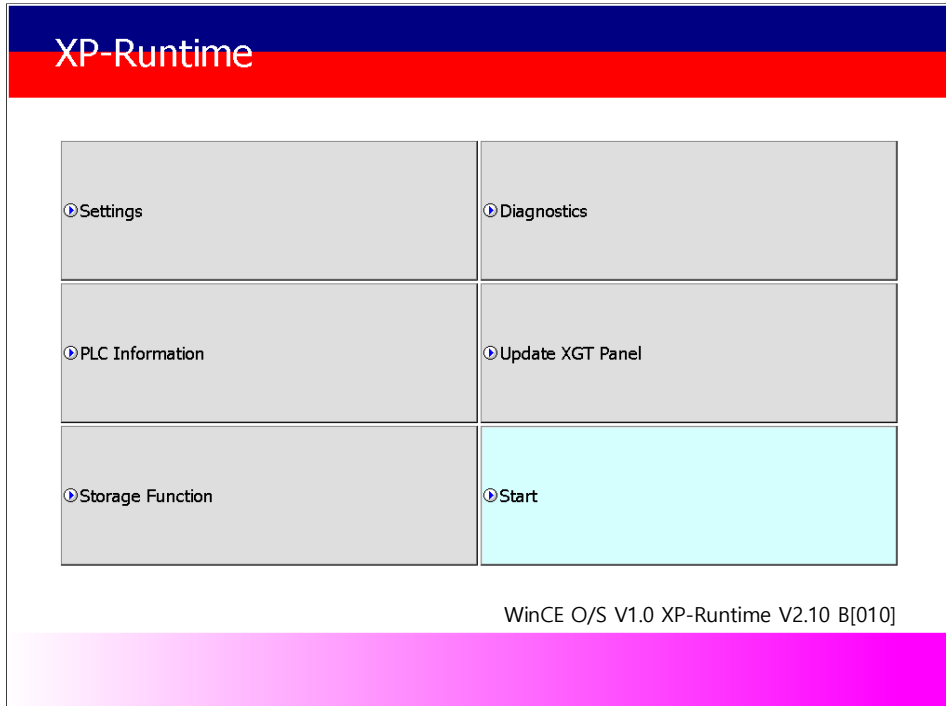

[XGT Panel Basic]

After booting the XGT Panel after turning on the power, the XP-Runtime main screen is displayed. Functions of each menu are as follows.

Menu	Meaning	Details	Note
Settings	Configuration menu of XGT Panel	Backlight Setting	Refer to <b>5.1 Settings</b>
		Touch Setting	
		DateTime Setting	
		Environment Setting	
		Ethernet Setting	
		Buzzer Setting	
		Sound Setting	
		XP-Remote Setting	
		Goto MainMenu	
Diagnostics	Diagnostics function of XGT Panel	Screen	Refer to <b>5.2 Diagnostics</b>
		Touch	
		Backup Memory/	
		Flash Memory	
		USB Memory	
		Serial	
		SD Card	
		Touch Sensitivity	
Goto MainMenu			

구분	의미	세부 항목	비고
PLC Information	PLC setting menu connected with XGT Paenl	Settings	Refer to <b>5.3 PLC Information</b>
		SHOW INFO	
		Program Monitor	
		OK	
		N:1 Settings	
Update XGT Panel	For updating XGT Panel	XGT Panel Update	Refer to <b>5.4 Update XGT Panel</b>
Storage Function	It is for using the storage devices used in XGT Panel	Project Download	Refer to <b>5.5 Storage Function</b>
		Project Upload	
		XGT Panel Update	
		Select USB	
		Cancel	

## 5.1 Settings

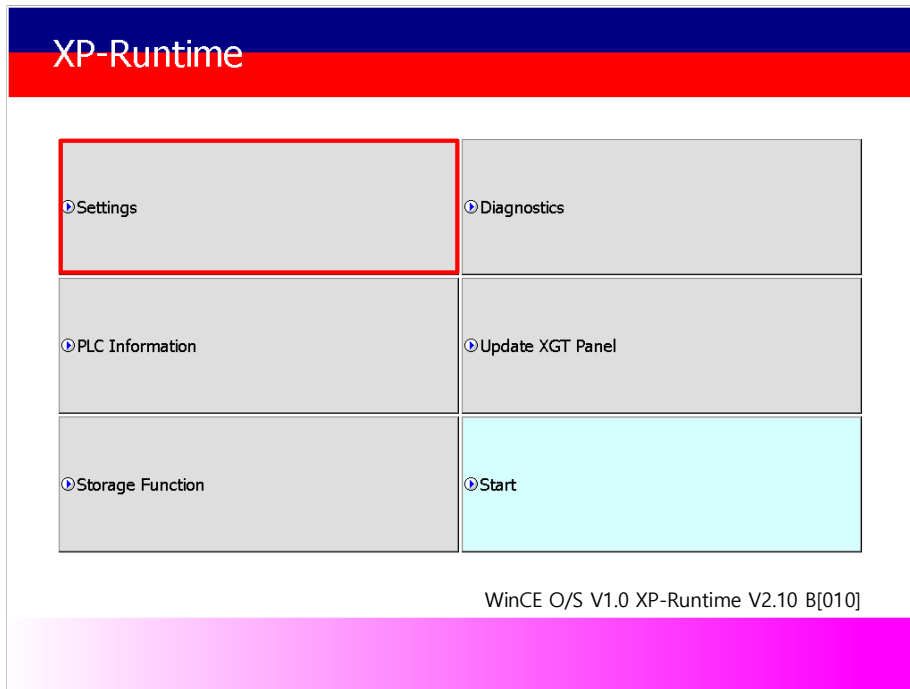

### 5.1.1 Backlight Setting

Press the [Backlight Settings] button on the [System Configuration] screen to go to the setup screen as follows.

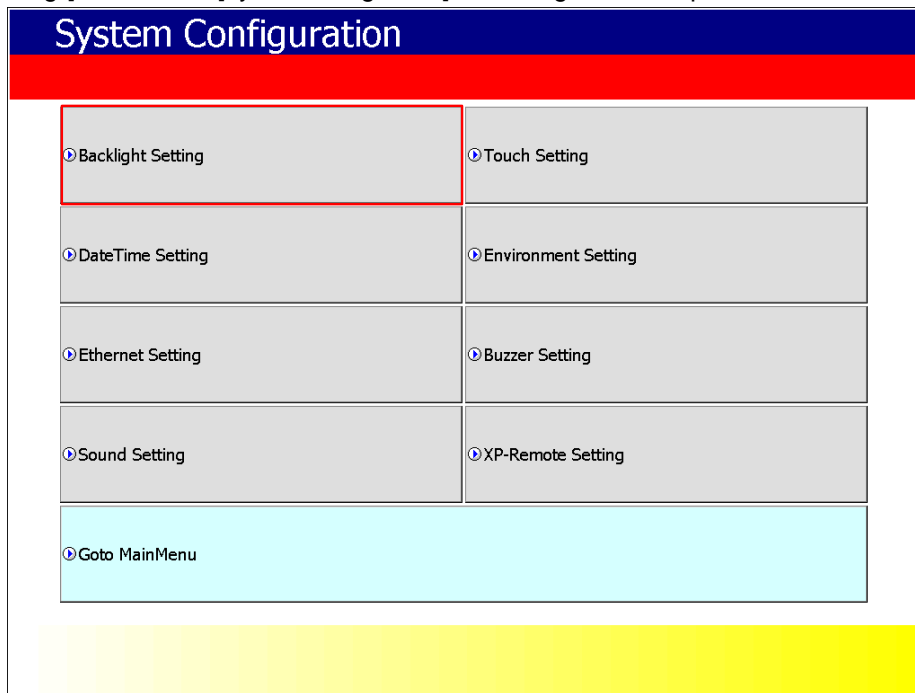

[XGT Panel Setting]



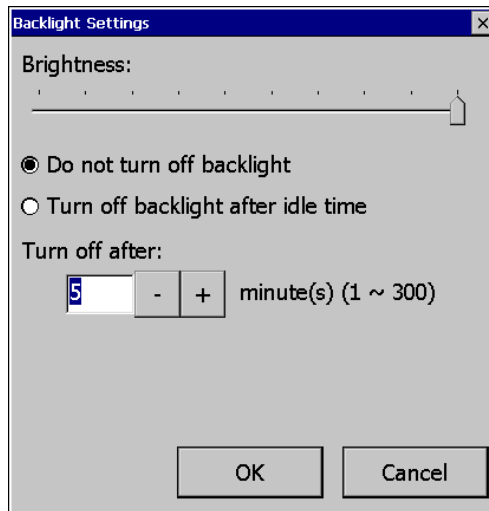

[Backlight setting]

[Explanation of the dialog box]

Menu	Explanation
Brightness	Backlight Brightness can be adjusted.
Do not turn off backlight	Backlight power is always on.
Turn off backlight after idle time	If you do not touch for a certain period of time, the backlight automatically turns off.
Turn off after	The backlight turns off after the set time (in minutes).

### 5.1.2 Touch Setting

You can adjust the sensitivity of the touch according to the type of gloves according to the work environment during touch operation. If you press [Touch Setting] on the System Configuration screen as shown below, the setting window will be activated and you can set the sensitivity according to the type of glove. You can set the sensitivity of the touch by user setting.

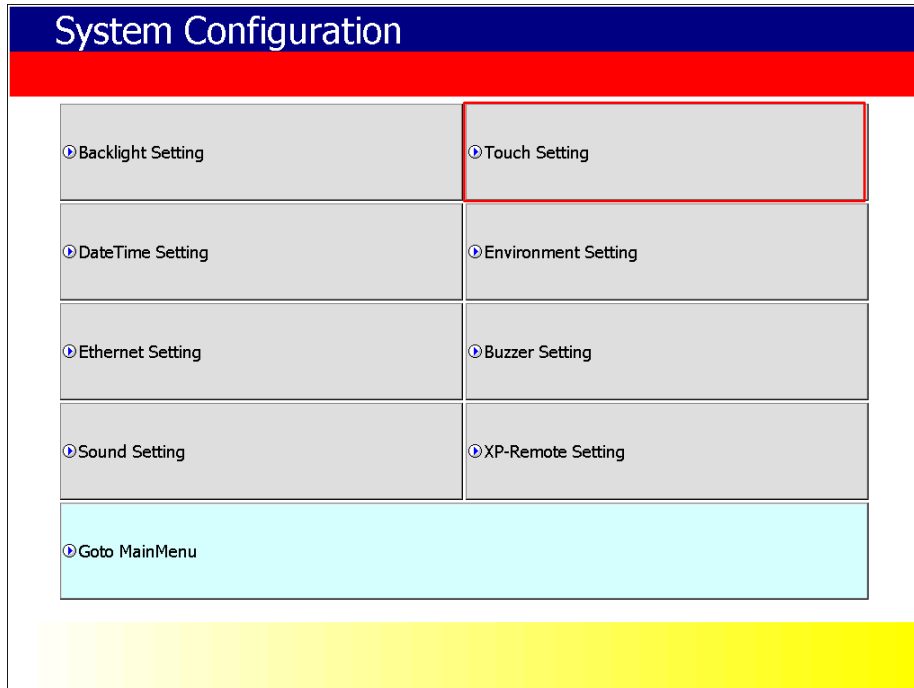

[XGT Panel Setting]

The detailed menu for Touch Setting is classified according to the version of the touch controller, and the menu for each version is configured differently.

#### Note

1. The detailed classification method for Touch Controller can be checked in the detailed menu item of the Diagnostics menu of XP-Runtime Version V3.0 or higher.
- 1) Touch Controller V1.0: Supports touch sensitivity function
- 2) Touch Controller V2.0: Touch sensitivity function not supported

5.1.2.1 Touch setting in Touch Controller V1.0

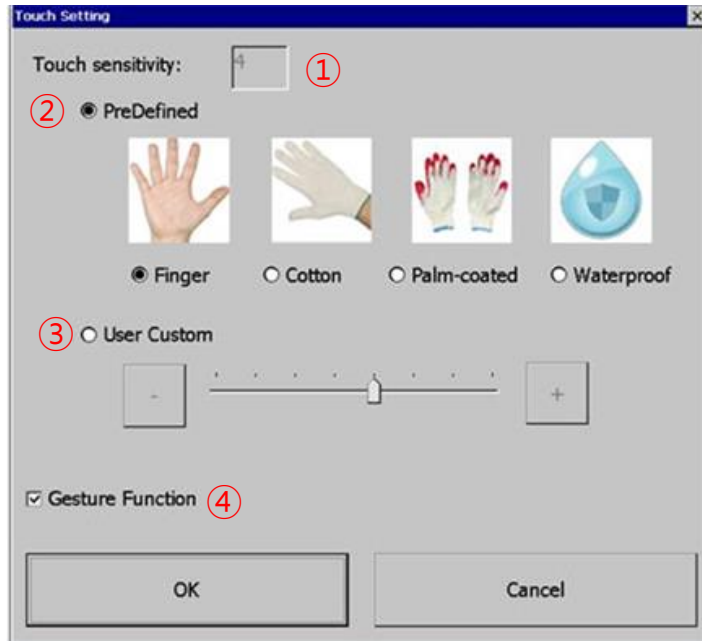

[Touch setting screen]

Menu		Explanation	Remark
Touch sensitivity		Displays the sensitivity for the set touch mode.	
PreDefined	Finger	An environment where you touch the screen with your bare hand.	Sensitivity by use environment Mode selection.
	Cotton	An environment where you wear cotton gloves and touch the screen.	
	Palm-coated	An environment in which coated gloves are worn and the screen is touched.	
	Waterproof	Environments where water is sprayed or condensation occurs on the screen.	
User Custom		User set sensitivity value.	
Gesture Function		A function to select whether to use the function using the gesture of the finger. When checked, screen switching and data list inquiry (history alarm view, logging view, file explorer, etc.) are possible through PAN and Flick operation.	Restrictions on use in water droplets required.

5.1.2.2 Touch setting in Touch Controller V2.0

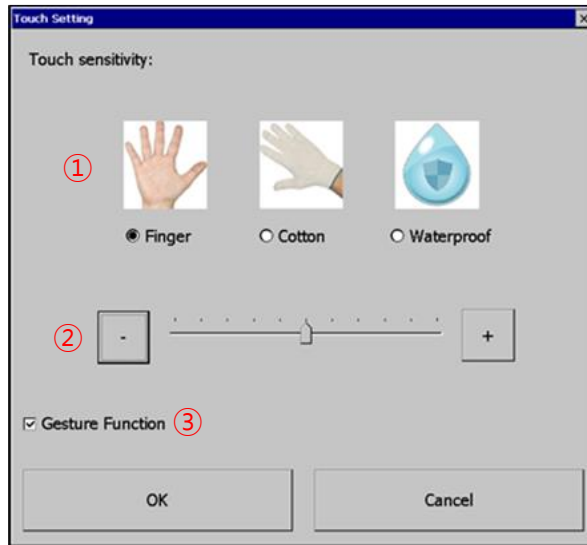

[Touch setting screen]

Menu		Explanation	Remark
Touch mode	Finger	An environment where you touch the screen with your bare hand	Sensitivity by use environment Mode selection
	Cotton	An environment where you wear cotton gloves and touch the screen	
	Waterproof	Environments where water is sprayed or condensation occurs on the screen	
Mode value Fine tuning	+	Increase sensitivity to selected touch mode	
	-	Reduces sensitivity to the selected touch mode	
Gesture Function		A function to select whether to use the function using the gesture of the finger. When checked, screen switching and data list inquiry (history alarm view, logging view, file explorer, etc.) are possible through PAN and Flick operation.	Restrictions on use in water droplets required

**알아두기**

- (1) When using in an environment where noise flows due to poor power and grounding, touch sensitivity is excessively increased. It may cause malfunction. Refer to 5.2.2 Touch Diagnosis Method and check if there is any malfunction when applying the current setting value before use.
- (2) When using Touch Controller V2.0, detailed adjustment function is not supported when OS and XP-Runtime are V1.8.xx and V3.10.xxxx respectively.
- (3) In an environment where water is sprayed on the screen or condensation occurs, touch malfunction may occur due to water droplets on the screen. Therefore, in such an environment, change the gesture function to the inactive mode.

### 5.1.3 DateTime Setting

You can set the date and time of XGT Panel by pressing [DateTime Setting] button on [System Configuration] screen as follows.

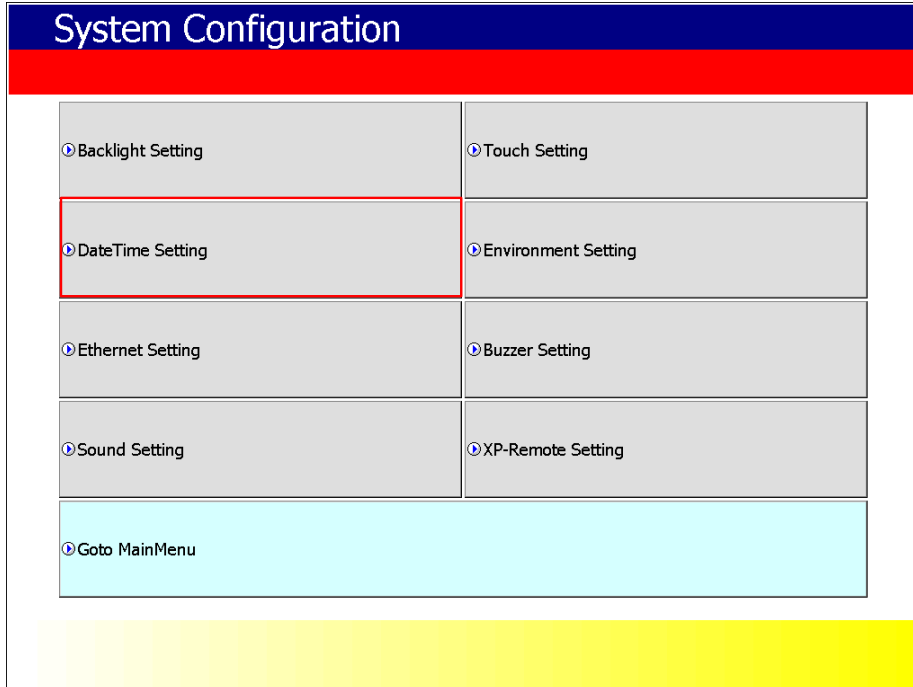

[XGT Panel Setting]

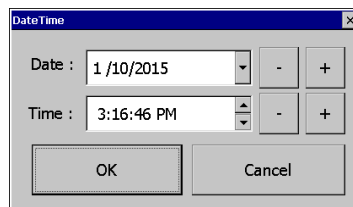

[Date / Time Setting]

**Note**

Date / time view and setting are also available in the device information view of the communication setting dialog of XP-Builder. For more information, See the XP-Builder User's Guide .

### 5.1.4 Environment Setting

If you press the [Environment Setting] button on the [System Configuration] screen to go to the setup screen as follows.

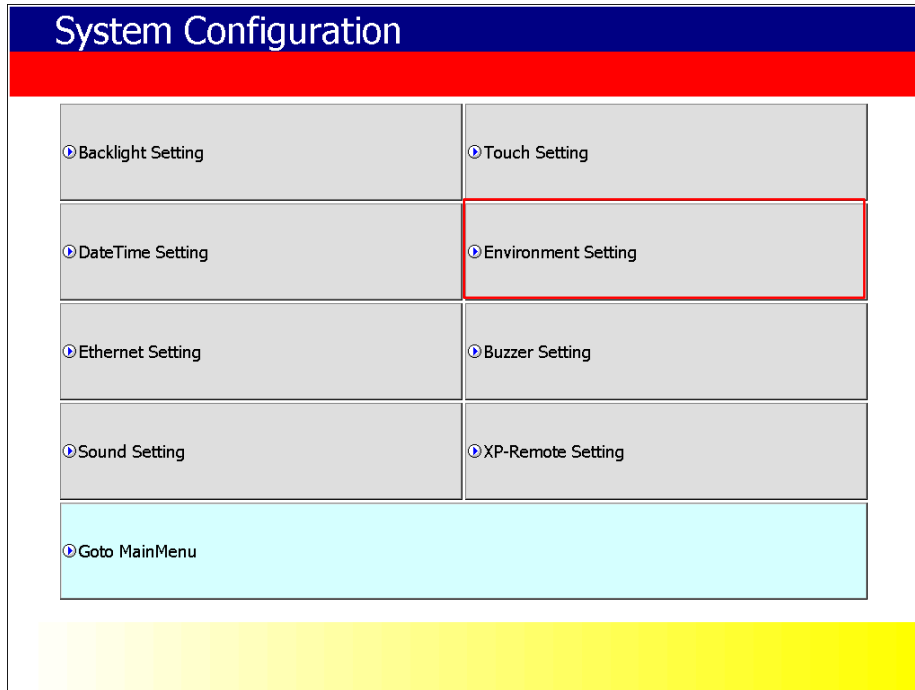

[XGT Panel Setting]

(1) Screen

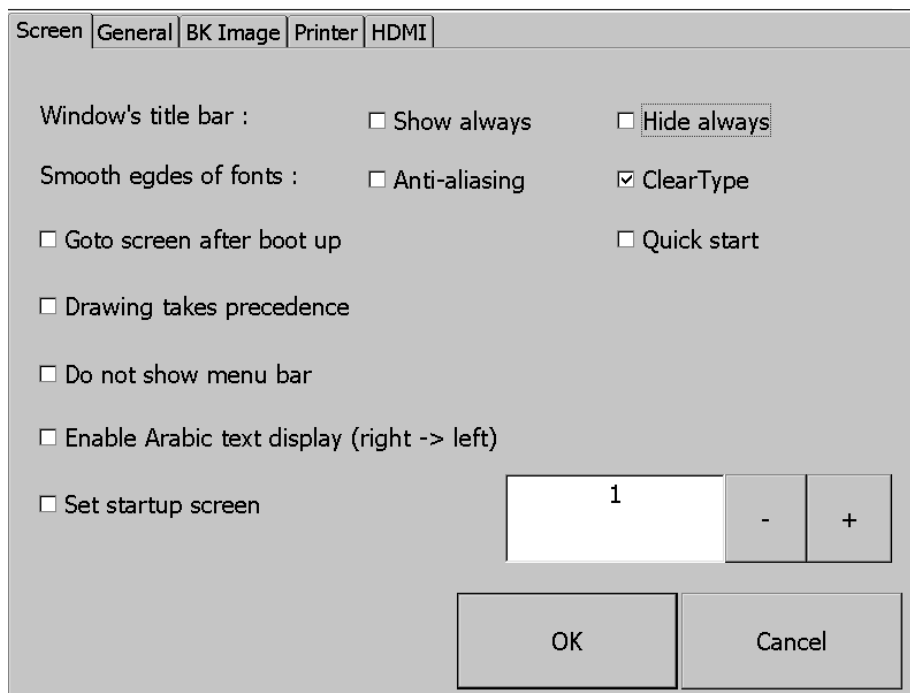

Menu	Explanation
Window's title bar : Show always /Hide always	<p>If you select [Show always], the title bar displays when a pop-up window is displayed on the screen. You can select and move the title bar of the pop-up window. If you select [Hide always] the title bar will not be displayed when a pop-up window is displayed on the screen, and you will not see it when you click the window screen blank.</p> <p>If you uncheck [Show always], [Hide always], the title bar will not be displayed when the pop-up window is displayed on the screen, and the title bar will appear when you click the window screen blank.</p>
Smooth edges of fonts : Anti-aliasing/ ClearType	<p>Smoothly handle the edge of each stroke when the letter is displayed. To do this, you can choose between Anti-aliasing and ClearType. Generally, applying ClearType is more poetic, but Anti-aliasing may be better, depending on the font type and font size. Smooth font display by selecting one of the two increases the load on the system, especially as the font size increases, it may have a performance impact on functions such as flow alarms. This feature is available on iXP, iXP2 and later models</p>
Goto screen after boot up	<p>After rebooting XGT Panel or downloading edit data, You will switch. If you disable this setting, Button to move to the screen.</p>
Quick start	<p>When I start the screen, I do not cache the image in advance, It does not appear. However, if you select this option, the initial screen may appear somewhat late.</p> <p>There is. In particular, if the screen contains animation objects, It may take a few seconds. The next screen transition is fast.</p>
Drawing takes precedence	<p>If you choose [Drawing takes precedence], the screen that you have already entered when switching the screen will display the image/value based on the data that was last displayed at that time. Then read the actual device value and display the image/value again. If the screen is entering for the first time, it will behave the same as when [Drawing takes precedence] is deselected.</p> <p>If you deselect [Drawing takes precedence] when switching the screen, read the actual device value and display the image/value. This may take some time to switch screens depending on the network situation or PLC response rate.</p>
Do not show menu bar	<p>In order to exit to the standby screen during screen monitoring, The window (menu bar) does not appear. If this is the case, You need to configure and use a special switch to exit the screen.</p>
Enable Arabic text Display (right-> left)	<p>Enables the right-to-left language.</p>
Set startup screen	<p>The screen corresponding to the number entered at the start of monitoring is displayed.</p>

(2) General

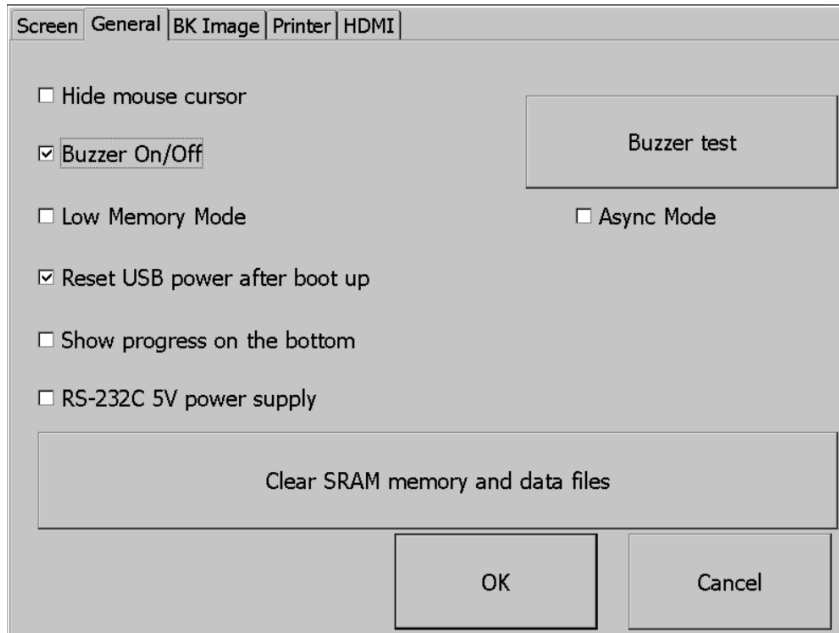

Menu	Explanation
Hide mouse cursor	Mouse cursor does not appear after scrolling.
Buzzer On / Off	You can set whether buzzer is used or not.
Buzzer test	You can test the buzzer.
Low Memory Mode	<p>XGT Panel starts monitoring the images used on the screen to speed up the screen operation.</p> <p>It will be loaded into memory before use. By the way, If a positive image is used, due to memory space constraints, all The image will not load. In this case, if the screen is not yet loaded Images are loaded, and there is not enough space, so unused images are retrieved from memory</p> <p>The operation to delete may be repeated, and the screen switching operation may be slowed down. In this situation</p> <p>Low Memory Mode "is recommended. In Low Memory Mode, you do not load the image before monitoring, but use only the original source of the image used in the project, which results in less memory usage and less load to load and delete images into memory.</p>
Async mode	<p>Ensures the order of operation when entering values by bit switch, word switch, multi-switch, etc. when [Async mode] is deselected. In other words, when 1, 2, 3 actions are performed by multiple switches or overlapped switches, 2 is performed when 1 action is completed, and 3 is performed only when 2 is completed. Therefore, if there is no response from the target controller in Operation 1, the actions 2 and 3 are also delayed even if the controller is different.</p> <p>When [Async mode] is selected, the value is entered by bit switch, word switch, multi-switch, etc. without ensuring order. In other words, when 1, 2, 3 actions are performed by multiple switches or overlaid switches, each action can be completed in the order of 2, 1 and 3 depending on the network situation or controller response speed. Although the order is not followed, it has the advantage of operating quickly for the rest of the controllers even if some of them do not respond.</p>



Reset USB power after boot up	When XGT Panel starts, it turns off USB power → On to initialize the connected device. The initial setting is On, and if the USB recognition speed is slow or not well recognized Uncheck, power on again and try again.
Show progress on the bottom	When you start monitoring by selecting [Start] menu on the XGT Panel main screen, It buffers the used image and shows the progress of the operation. (fast Do not show progress if you make a start setting). At this time, If you check the [Show Lower] check box, this progress will be simplified and displayed at the bottom of the screen. Is displayed. This option can be applied when using the default screen image.
RS-232C 5V power supply	Sets whether the 5V power output is enabled at the 9pin D-sub terminal for RS-232C communication. This feature is available on iXP, iXP2 and later models.
Clear SRAM memory And data files	Delete all files you've downloaded on your device. However, connecting to the device If a password is set, you must enter the password before you can delete it. The password is the device connection password that you enter when downloading a project, This can be set in XP-Builder on the Device Information View tab of the Communication dialog box. The files to be deleted include user project data, web server, VNC startup module, option card Driver, RAPIEnet communication setting data, XP-Manager setting data etc. from user PC All downloaded data is included. Set using the configuration menu of the machine. The contents are kept uninitialized. If the menu language is not English, A device reboot is required to delete files.

## Chapter 5 XGT Panel Menu Explanation

### (3) BK Image

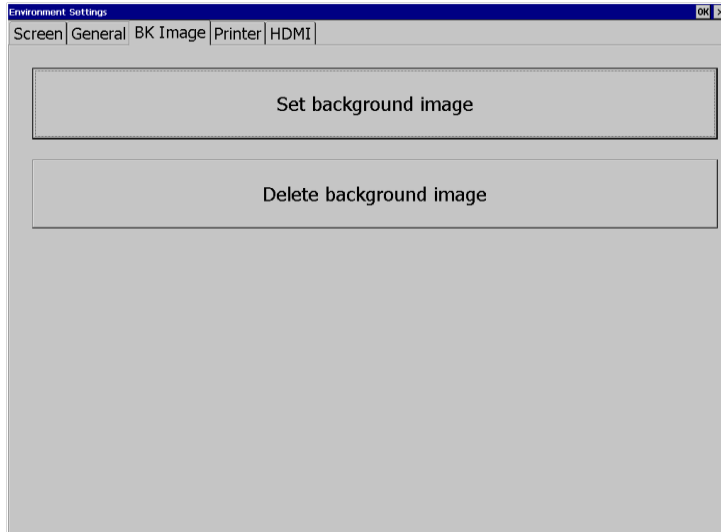

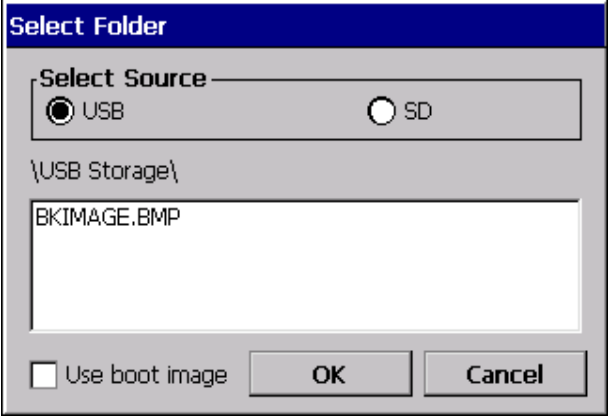
Menu	Explanation
Set background image	<p>If you select an image, the standby screen and desktop are selected after the XGT Panel is powered on.</p>  <p>If [Use boot image] option is selected, images with resolutions other than XGT Panel, It can not be used unless it is a 24bit BMP image.</p>
Delete background image	<p>When you select an image, the XGT Panel is powered on and the standby screen and desktop are selected.</p> <p>Set to image. To turn off background settings, click the Clear Background button. Just press it.</p> <p>If you select the Use boot image option, you cannot use it unless it is an image with a resolution different from the XGT Panel or a 24bit BMP image.</p>

### (4) Printer

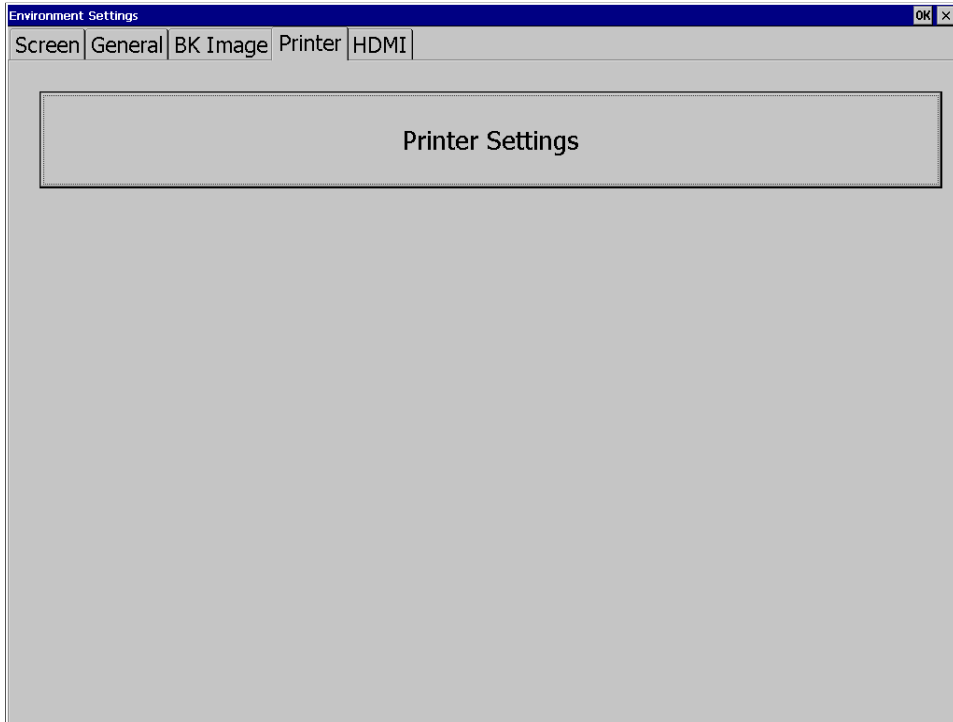

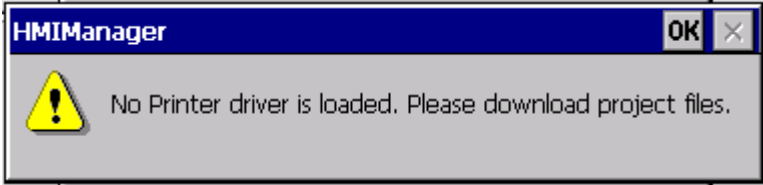
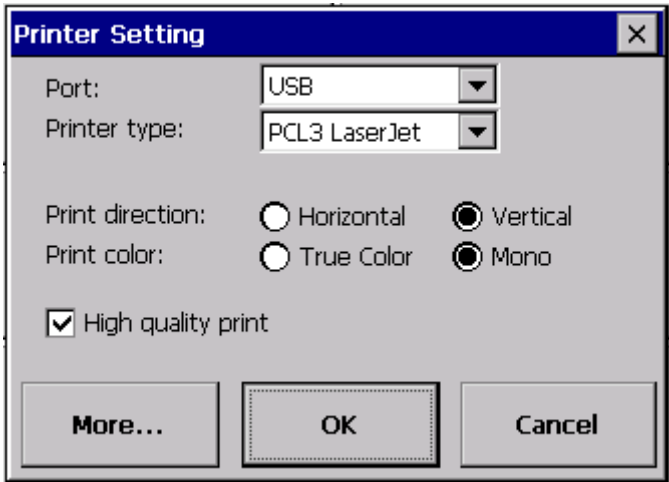
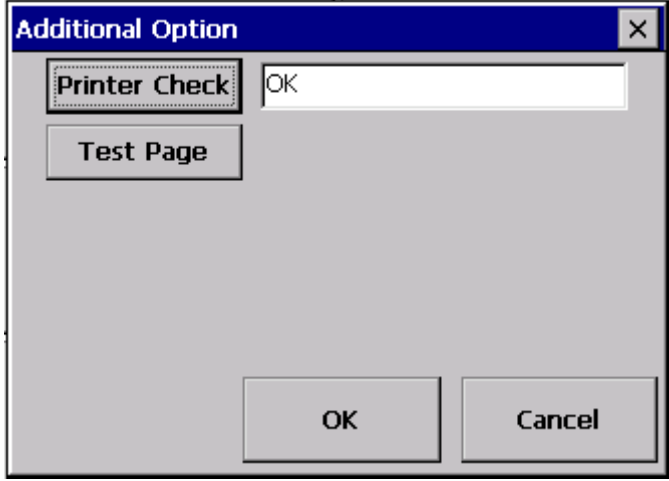
Menu	Explanation
<p>Printer Settings</p>	<p>Displays additional printer print settings dialogs. If there is no printer information You should download from XP-Builder with the following message. From XP-Runtime, go to Start menu and prepare for downloading. After using the printer, you can use the menu.</p>  <p>&lt;No printer driver and information → Download Required&gt;</p>   <p>&lt;Printer Driver and Information Available&gt;</p>

Printer Settings	Menu	Explanation
	Port	Connection method: Displays the connection method.
	Printer type	Printer type: Displays the printer type.
	Print direction	Orientation: Set whether it is horizontal or vertical.
	Print color	Print color: Set whether it is color or black and white.
	High quality print	Print quality: Set whether to print advanced.
	More ...	View additional properties: Displays additional properties. Printer Properties If you have made any changes, check whether you want to save it, Go to the dialog box.
	OK	Save the settings.
	Cancel	Cancels the setting.
	Printer Check	Diagnose connectivity: Diagnoses the connection status of the printer. this The functions of the printer (LK-P30, LK-P41, LK-P43) Support. Press the button to the right of the current status Displays a message. If the printer is off You can turn it on, connect the cable again, There is.  * Message Type * One. OK: normal 2. No Printer: Not compatible with printer 3. Cover Open: Paper cover opened 4. Paper Empty: Out of paper
	Test Page	Test printing: To test the printout status Function. It prints the following information and briefly Outputs the printing status.  <Example of test page> ***** Test page ***** DateTime: 2014-02-04 10:00:00 XP-Runtime version: 1320 Printer driver version: 1.00 Printer name: PCL3 LaserJet Port: USB *****

## (5) HDMI

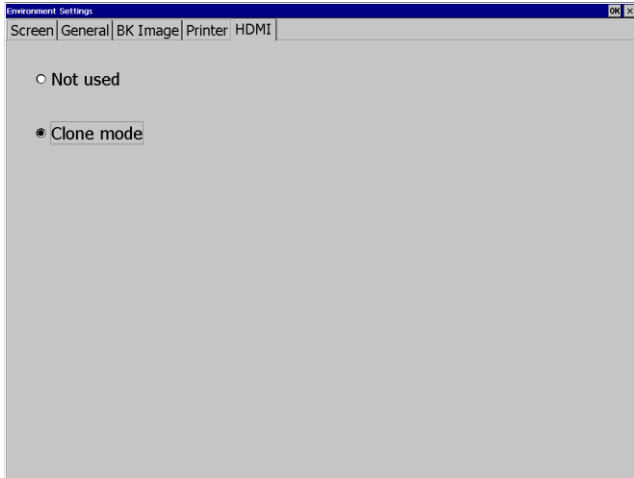

<Clone mode>

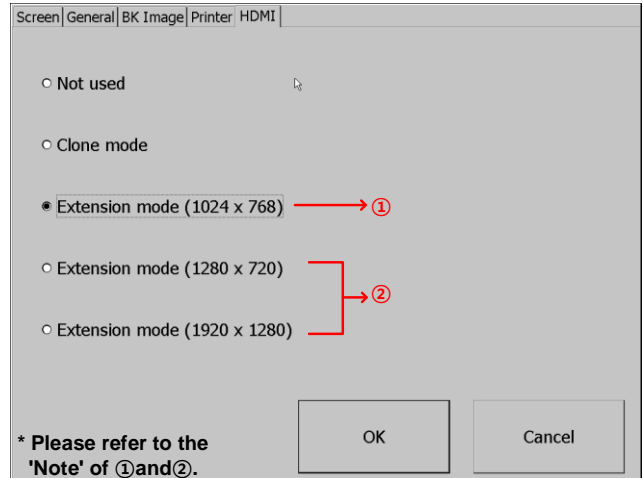

<Extension mode>

Menu	Explanation
Not used	HDMI function is disabled.
Clone mode	The same screen is displayed on the monitor connected by HDMI.
Extended mode (To be implemented)	Expands the screen to a monitor connected via HDMI.

### Note

- (1) ① is the same resolution as HMI.  
Displayed as 'iXP2 0800 :800 X 600, iXP2 10/12/1500 : 1024 X 768'.
- (2) ② Extension mode 1280 X 720, 1920 X 1280 is a fixed resolution.

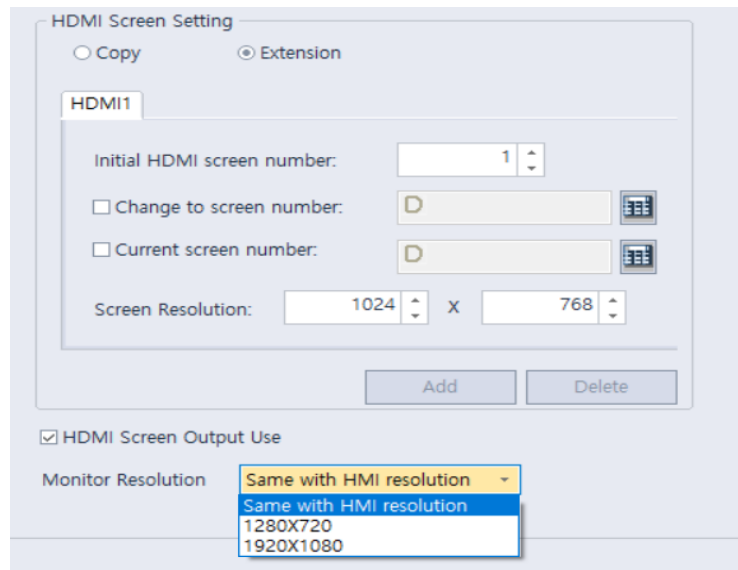

### 5.1.5 Ethernet Setting

If you press the [Ethernet Setting] button on the [System Configuration] screen as below, you can set the IP to use Ethernet.

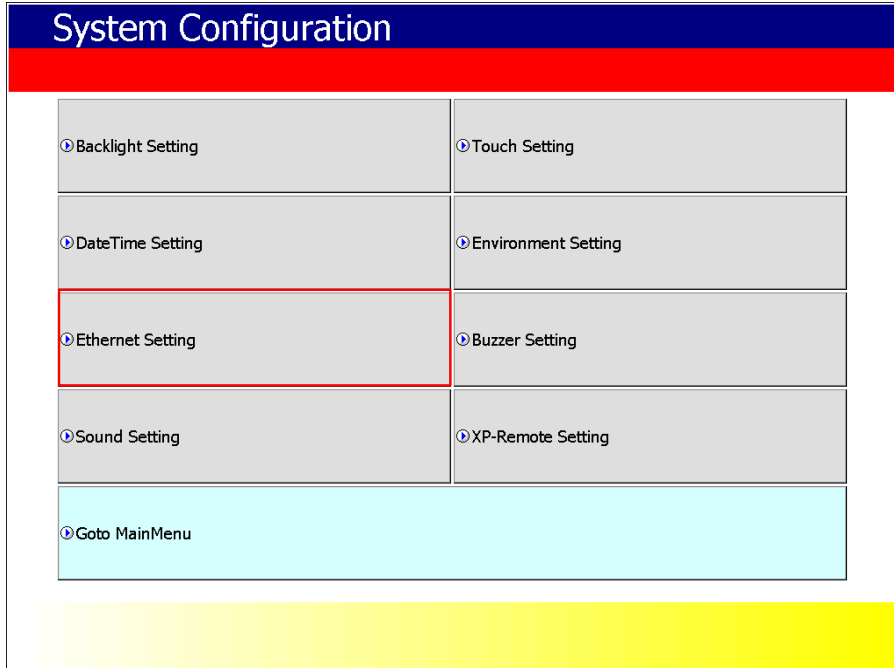

You can change the IP by pressing the [Set] button for each item of IP address, Subnet Mask and Gateway. If you click [OK] button, changed IP information will be saved. Two Ethernet ports [LAN 0] and [LAN 1] can be set respectively.

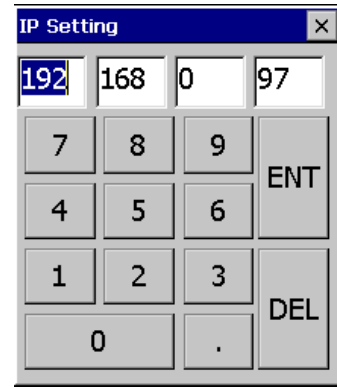
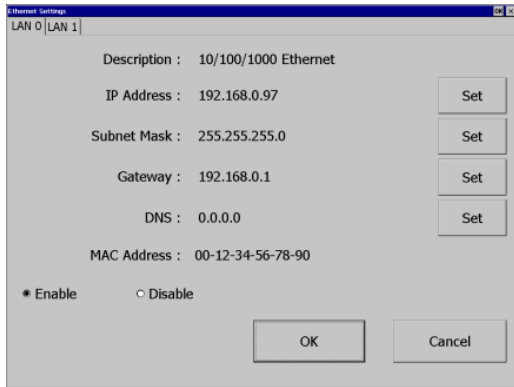

**Note**

For 1: 1 connection with PC, it is recommended to set as follows.

- |  |   |
|--|---|
| <p>1) XGT Panel setting</p> <ul style="list-style-type: none"> <li>- IP address: 192.168.0.10</li> <li>- Subnet Mask: 255.255.255.0</li> <li>- Gateway: 192.168.0.1</li> </ul> | <p>2) PC setting</p> <ul style="list-style-type: none"> <li>- IP address: 192.168.0.11</li> <li>- Subnet Mask: 255.255.255.0</li> <li>- Gateway: 192.168.0.1</li> </ul> |
|--|---|

If you press the [Disable] button and reboot, the device will not use Ethernet. If this is the case, You can get the effect. To use Ethernet again, press [Enable] button and reboot.

## 5.1.6 Buzzer Setting

You can adjust the volume and tone of Buzzer of XGT Panel.

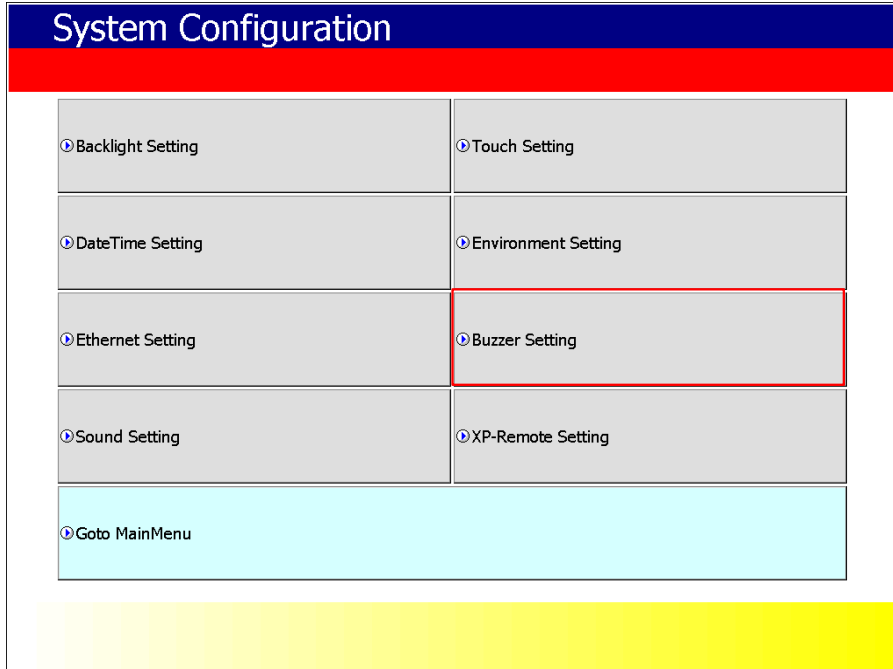

[XGT Panel Setting]

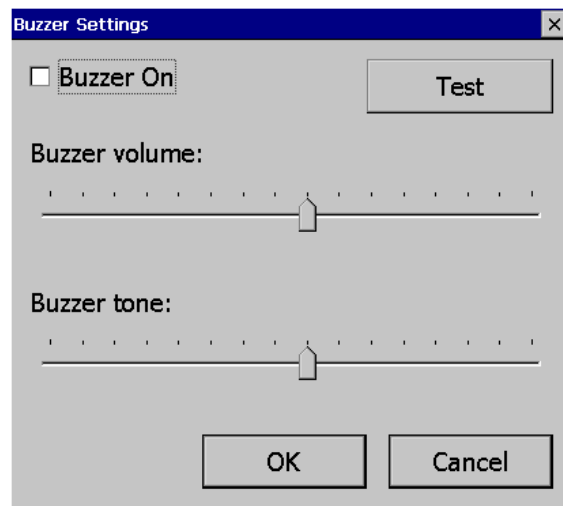

[Buzzer setting]

[Explanation of the dialog box]

Menu	Explanation
Buzzer On	You can turn on or off the buzzer sound generated when the selection is made.
Buzzer volume	You can adjust the volume of the buzzer.
Buzzer tone	You can adjust the height of the buzzer.



### 5.1.7 Sound Setting

You can adjust the volume of XGT Panel.

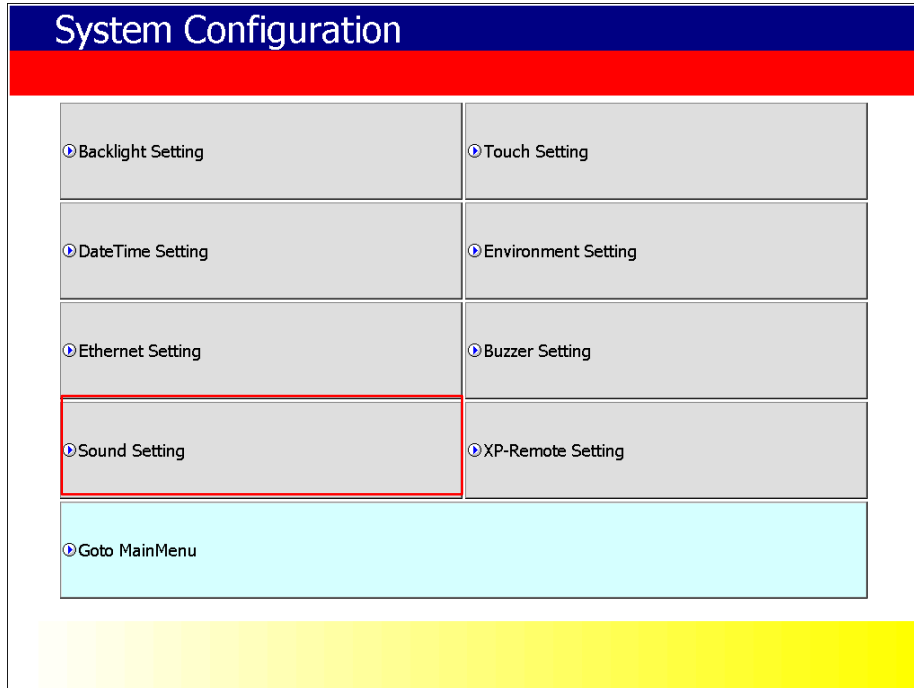

[XGT Panel Setting]

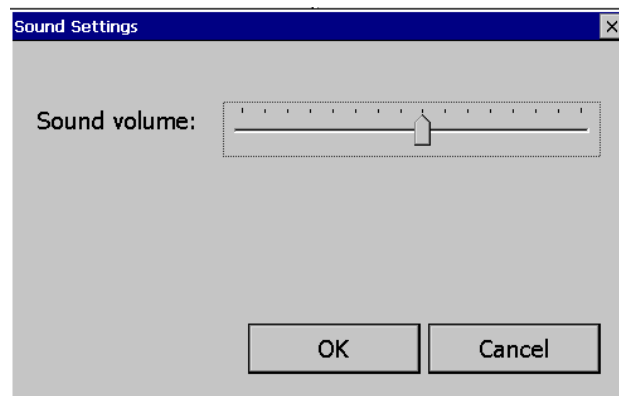

[Sound setting]

## 5.1.8 XP-Remote Setting

You can change the settings for XP-Remote that can remotely control the XGT Panel.

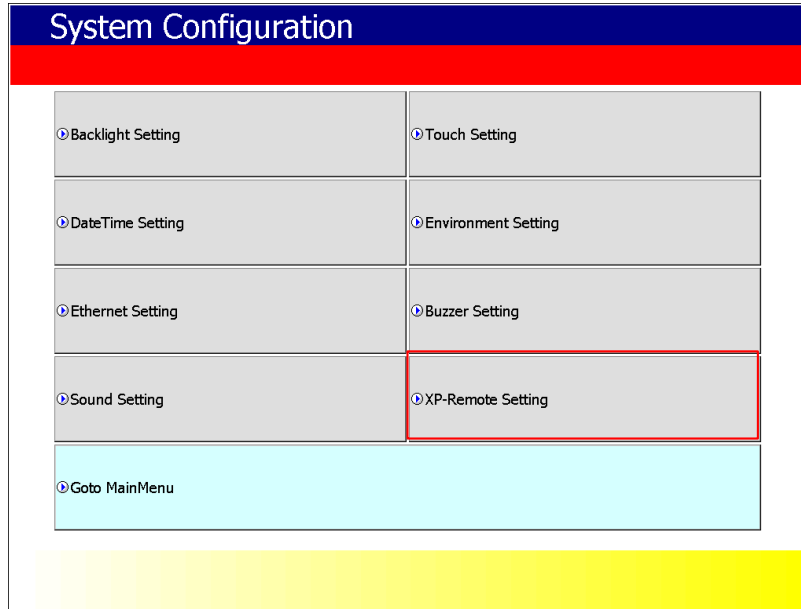

[XGT Panel Setting]

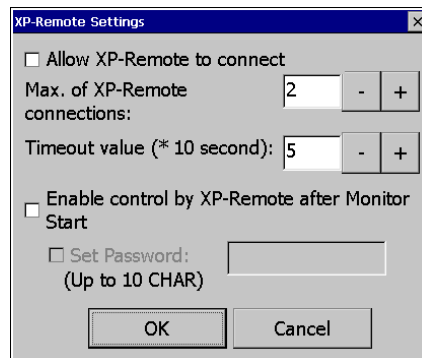

[XP-Remote setting]

[Explanation of the dialog box]

Menu	Explanation
Allow XP-Remote to connect	Allow connection of remote XP-Remote.
Max. of XP-Remote	Specify the maximum number of XP-Remote that can be connected to XGT Panel.
Timeout value	If there is no communication request from XP-Remote within the designated time, communication is stopped, If XP-Remote has operation authority, it recovers operation authority. (10 seconds ~ 300 seconds)
Enable control by XP-Remote after Monitor Start	After XGT Panel starts to monitor, operation permission status is automatically set.
Set Password	You can set it to enter a password when you request a connection from XP-Remote.

### Note

For details of XP-Remote, refer to the XP-Remote User's Manual.

## 5.2 Diagnostics

This chapter explains the functions that can be used to diagnose communication terminal, screen and touch function of XGT Panel. If you click the [Diagnostics] button on the main screen of XGT Panel, a menu for diagnosing each function of XGT Panel is displayed.

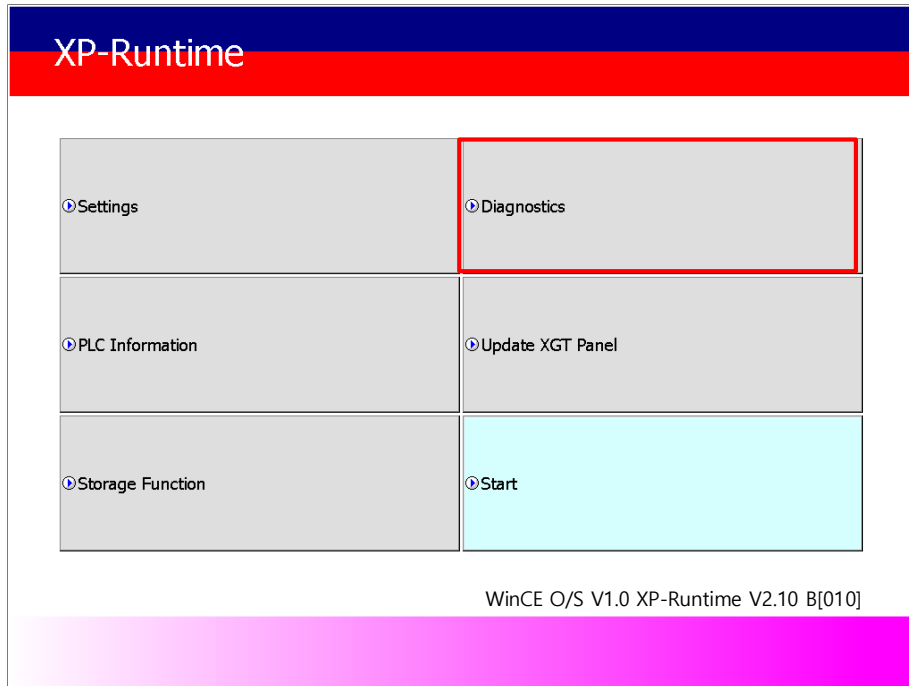

[XGT Panel Basic]

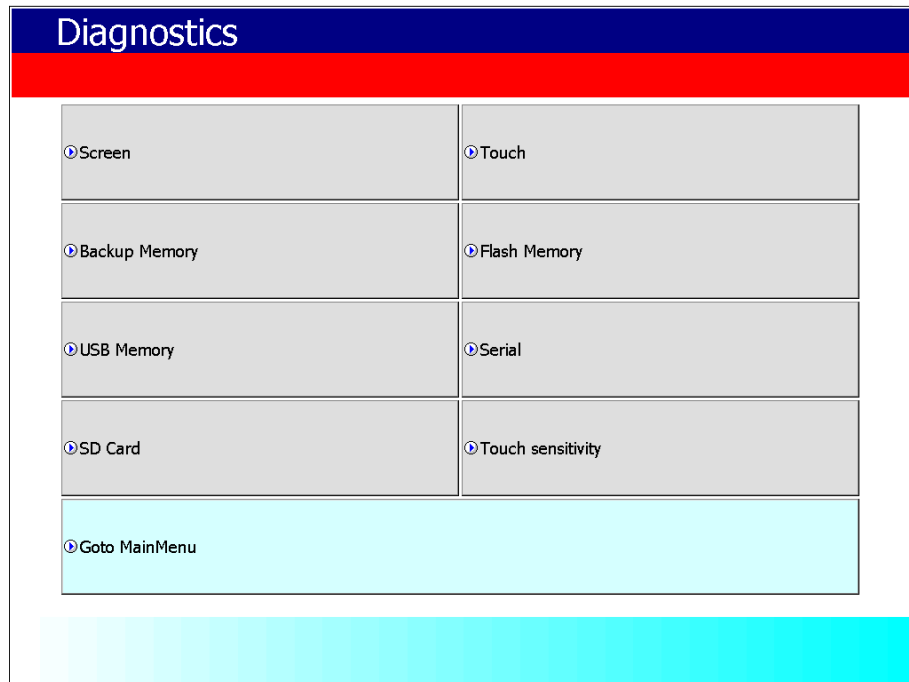

[XGT Panel Diagnostics]

### 5.2.1 Screen Diagnostic

When you press the [Screen] button, the screens with different colors are displayed in succession with the buzzer sound. After all the screens for diagnosis are displayed, the graph will appear and the [Close] button will appear in the upper left corner. When this [Close] button is pressed, Returns to the Diagnostics screen.

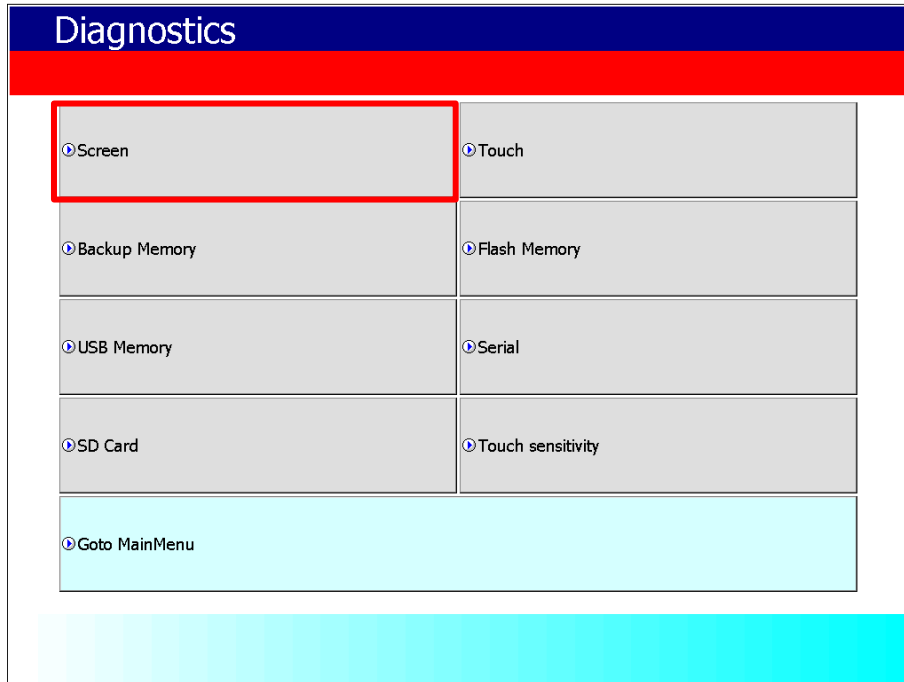

[XGT Panel Diagnostics]

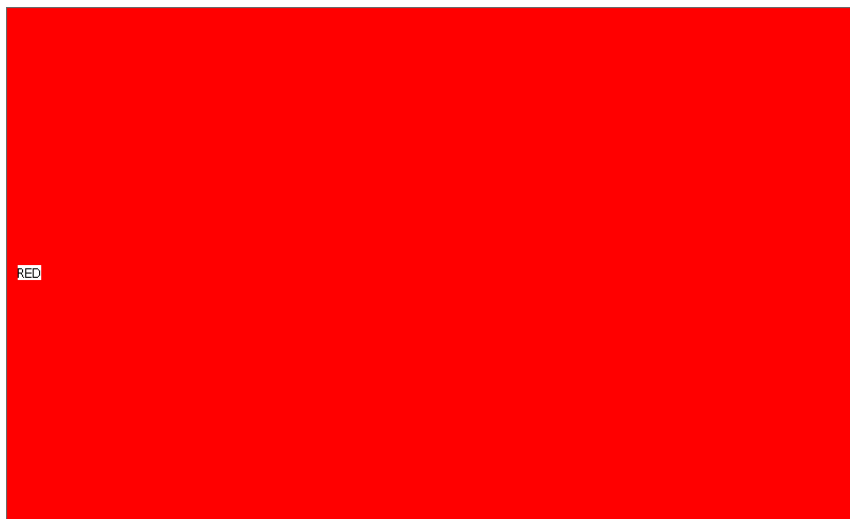

[Screen Diagnostic]

<b>Screen order</b>	Red → Green → Blue → Black → White → Graph
---------------------	--

### 5.2.2 Touch Diagnostic

When you press the [Touch] button, the diagnostic screen appears. If you touch the screen, you can see that it is displayed like the picture below. Press the [OK] button to exit the screen.

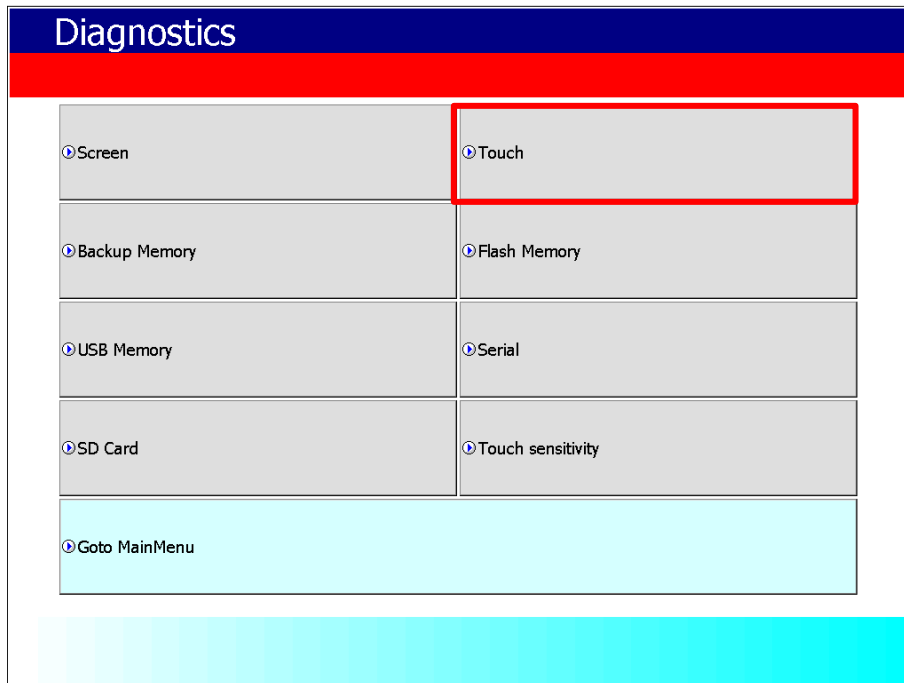

[XGT Panel Diagnostics]

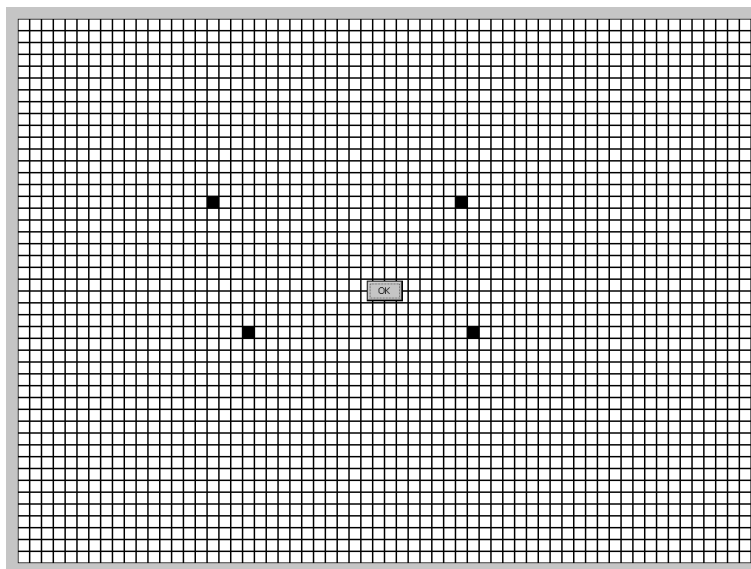

[Touch Diagnostic]

### 5.2.3 Backup Memory Diagnostic

If you press the [Backup Memory] button, you can see the diagnostic results in the confirmation window.

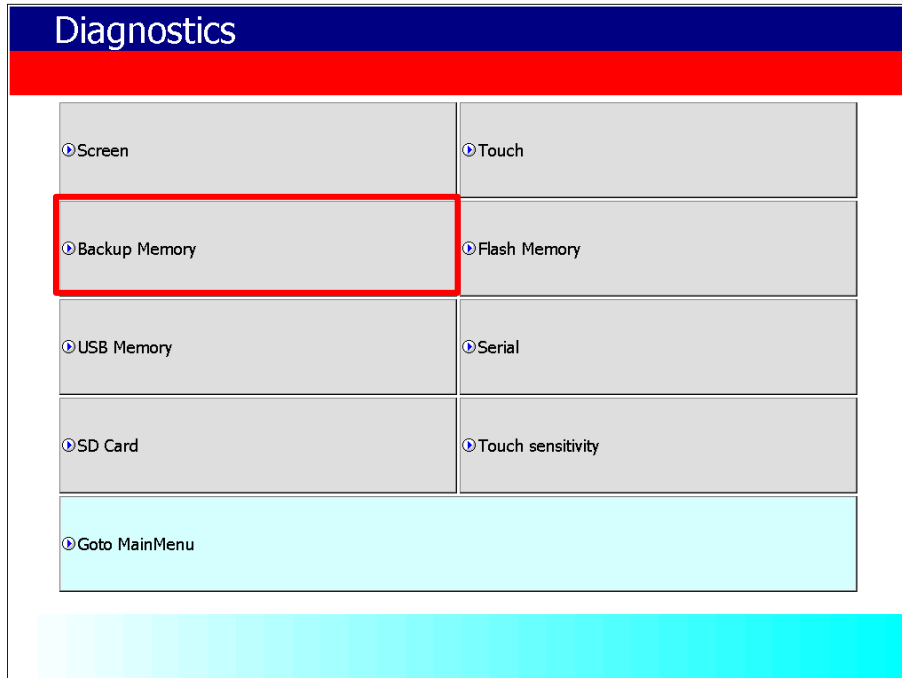

[XGT Panel Diagnostics]

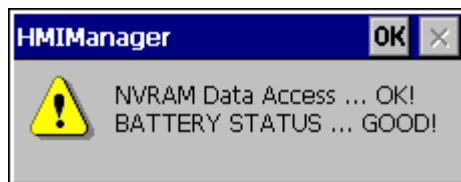

[Backup Memory Diagnostic]

#### Note

- (1) If 'NVRAM Data Access ~~ Fail' occurs, take A/S action.
- (2) If 'BATTERY STATUS ~~ BAD' occurs, you have to replace the battery through A/S.  
If the rear setting switch 1 is set to B, set it to ON. B is a mode without backup battery.

### 5.2.4 Flash Memory Diagnostic

When you press the [Flash Memory] button, the diagnostic results appear in the confirmation window.

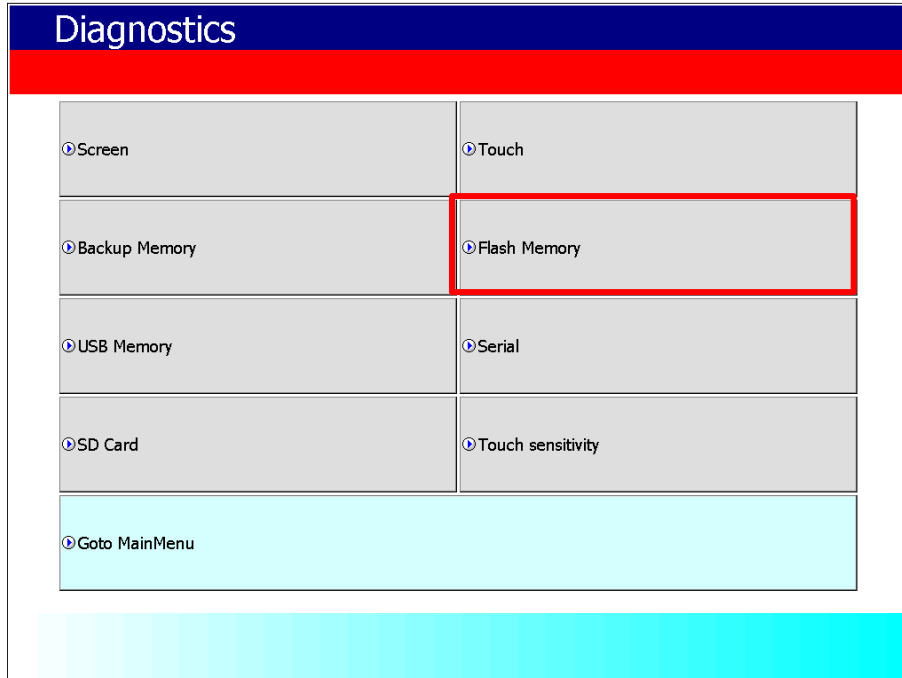

[XGT Panel Diagnostics]

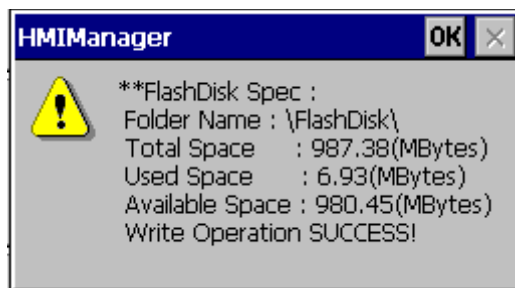

[Flash Memory Diagnostic]

**Note**

1. If "Read Disk Information Error!" Occurs, please contact us.
2. Space allocation of Flash Disk may depending on O/S version.

## 5.2.5 USB Memory Diagnostic

When you press the [USB Memory] button, the diagnostic result appears in the confirmation window.

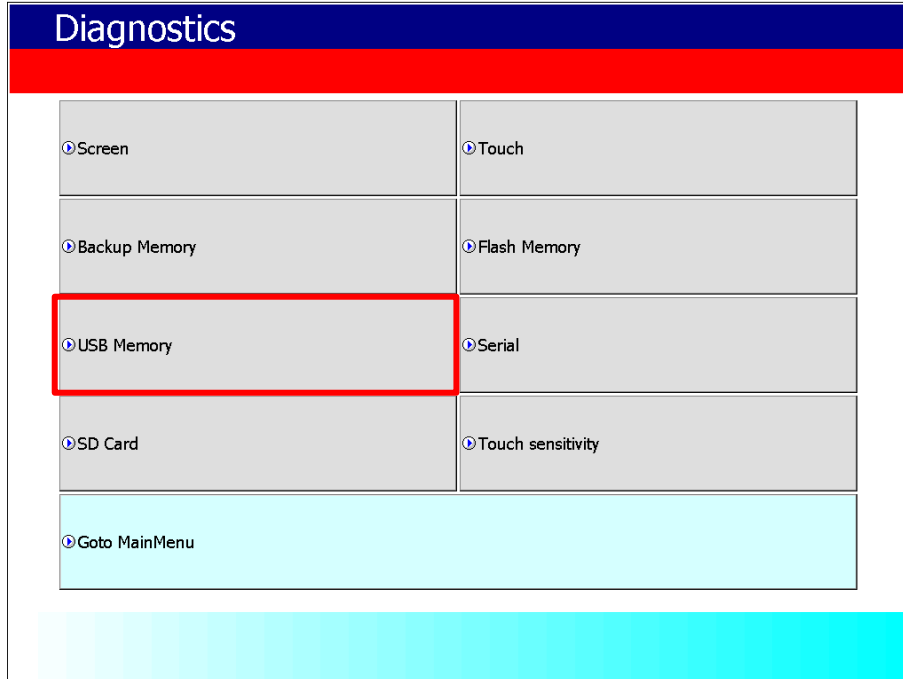

[XGT Panel Diagnostic]

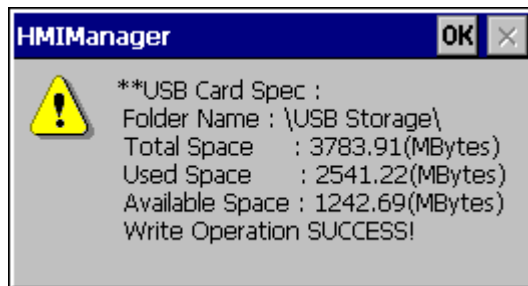

[USB Memory Diagnostic]

### Note

If USB memory is installed and 'Read Disk Information Error!' Occurs, remove it, insert it again and test do it. If the error message occurs repeatedly, contact Customer Service.



### 5.2.6 Serial Diagnostic

Diagnostic function for serial communication port such as RS-232C, RS-422. Press the [Serial] button to diagnose the serial ports installed on the XGT Panel. (However, for diagnosis, loop-back terminal must be connected to each port)

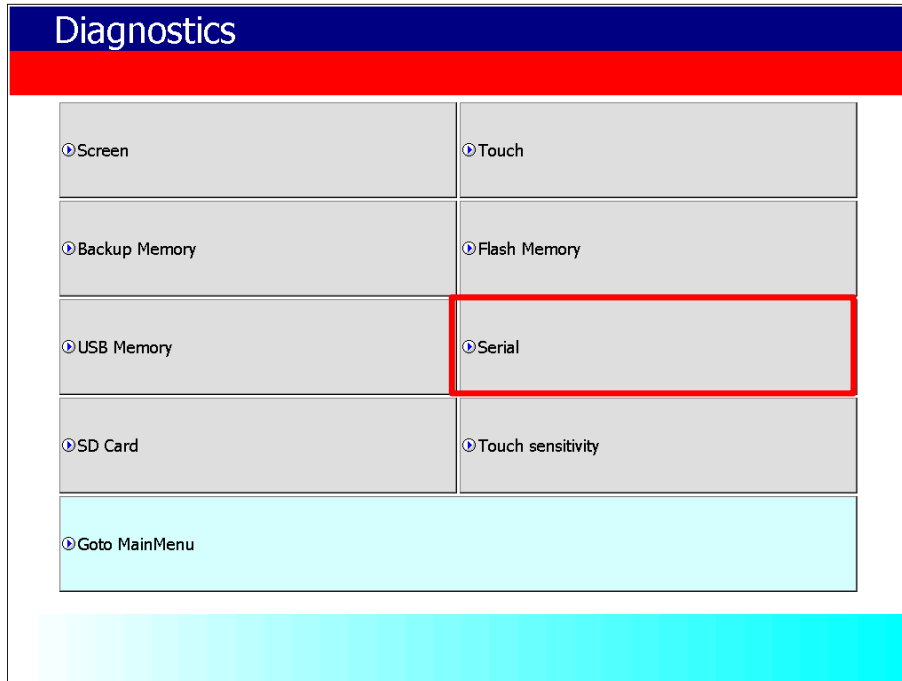

[XGT Panel Diagnostic]

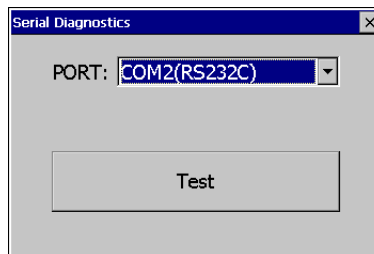

[Serial port selection screen]

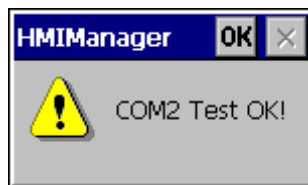

[Serial Diagnostic]

## Chapter 5 XGT Panel Menu Explanation

Please make RS-232C port terminal as below. (Connect pins 2 and 3.)

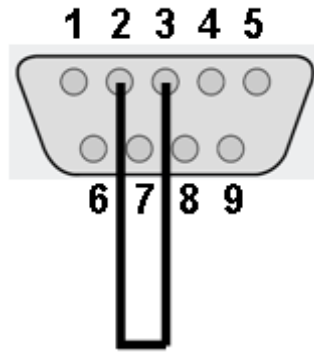

Connect the RS-422/485 port terminals as shown below.  
 (In case of RS-485 communication, connect pin 1, pin 3, pin 2 and pin 4)

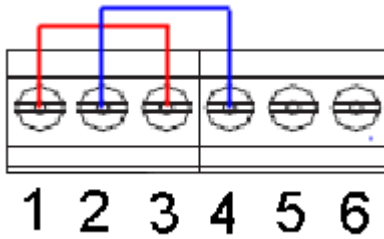

Pin number	name	function
One	TX +	Data transmission
2	TX-	Data transmission
3	RX +	Receive data
4	RX-	Receive data
5	SG	Signal Ground
6	PE	PE

### 5.2.7 SD Card Diagnostic

Displays information of SD card memory inserted in XGT Panel. Press the [SD Card] button to diagnose the SD memory mounted on the XGT Panel

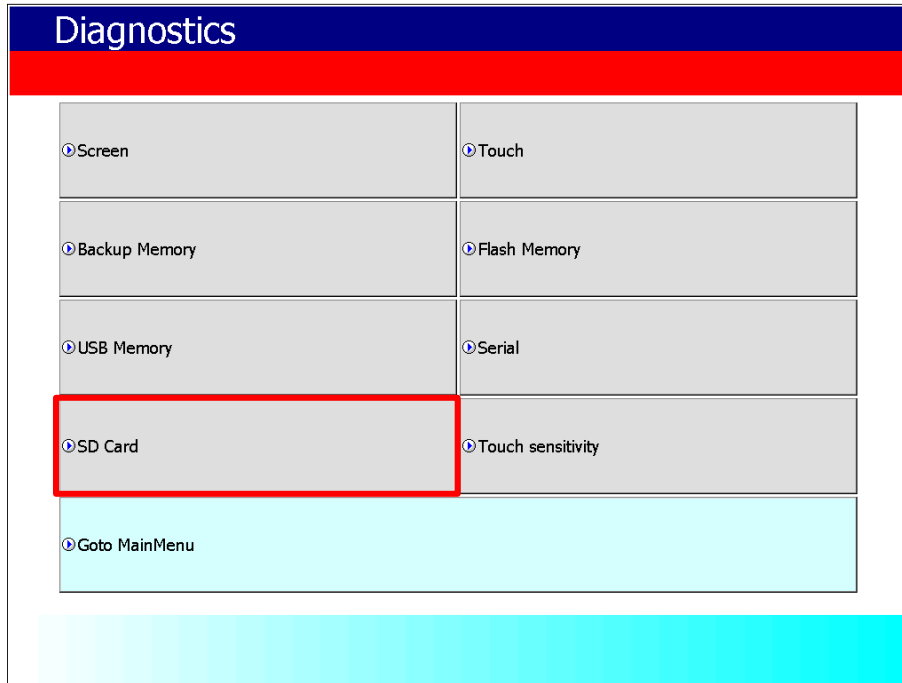

[XGT Panel Diagnostic]

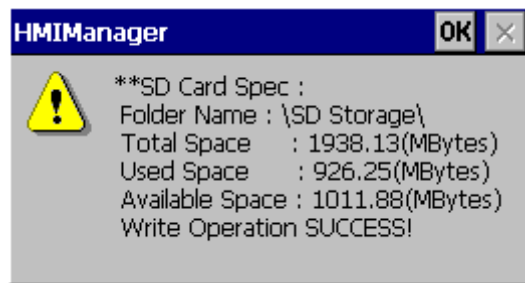

[SD Card Diagnostic]

**Note**

If 'Read Disk Information Error!' Occurs when an SD card is installed, remove it, insert it again, and test it.  
If the error message occurs repeatedly, take A / S action.

### 5.2.8 Touch Sensitivity

This function is visually displays the noise coming from the iXP2 series environment on the touch screen.

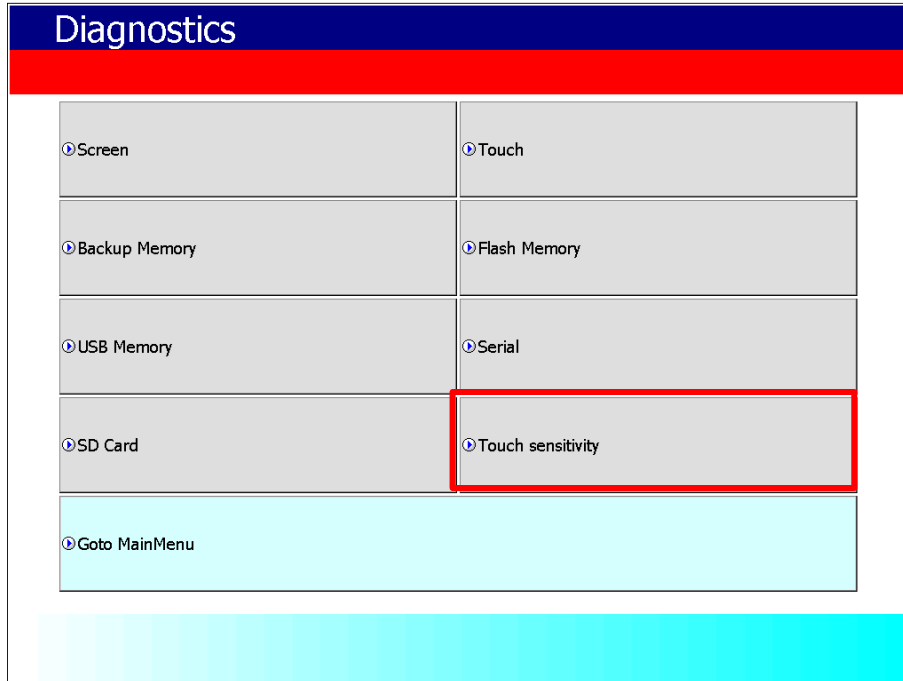

[XGT Panel Diagnostic]

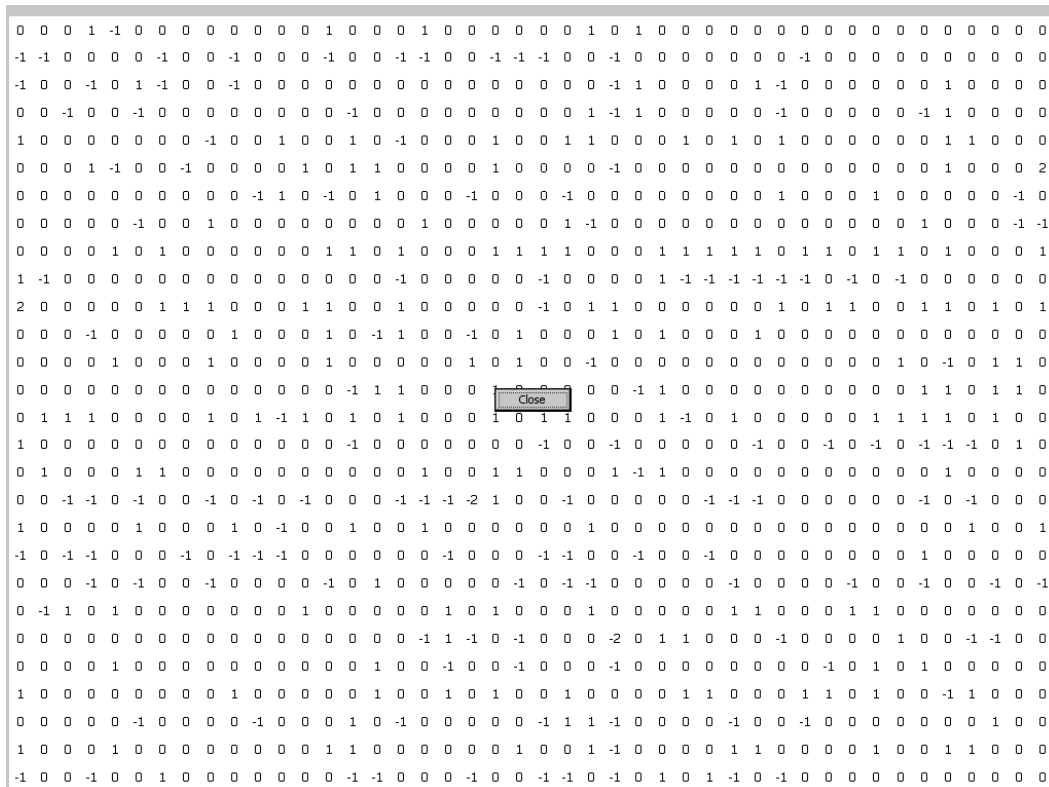

[Touch Sensitivity Diagnostic]

### Note

1. Touch Sensitivity is only able to check if noise is flowing into iXP2.
2. When touch is input, the value around the input area is increased. If the value of the non-touch area changes drastically, please take A/S action.
3. Whether or not the Touch Sensitivity function is supported depends on the version of the Touch Controller.
  - 1) Touch Controller V1.0: Supports Touch Sensitivity function
  - 2) Touch Controller V2.0: Touch Sensitivity function not supported

### 5.3 PLC Information

The PLC information view function is to view the connected XGT Panel information and CPU information and history of the target PLC.

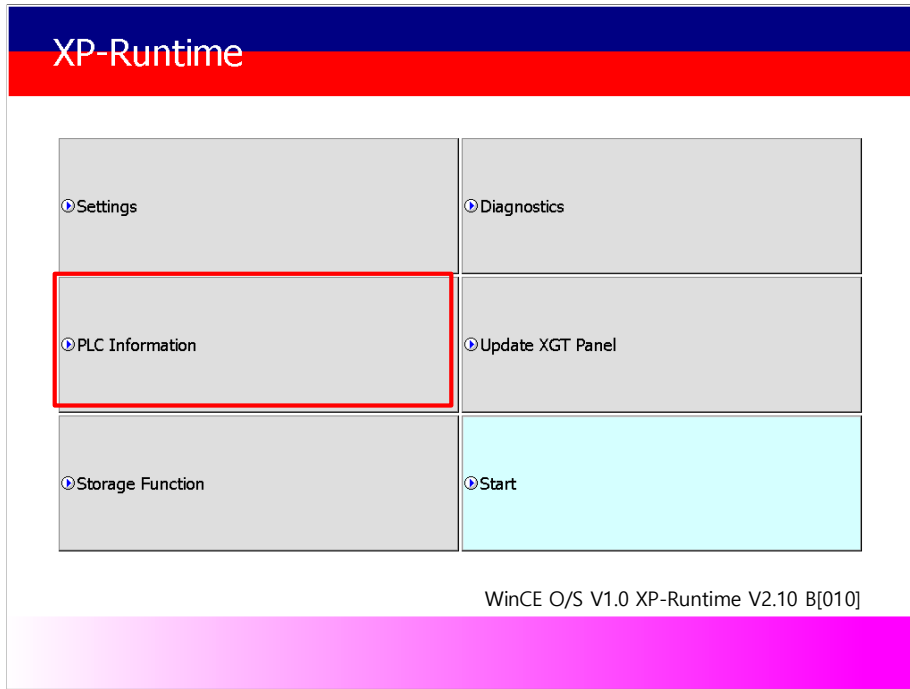

[XGT Panel Basic Screen]

**Note**

PLC connection status can be viewed only when project data is transferred to XGT Panel.

### 5.3.1 PLC Communication Setting

[Settings] is a function to change communication parameters of PLC communicating with XGT Panel, and you can change PLC communication setting items by clicking [Settings] button



[PLC information]

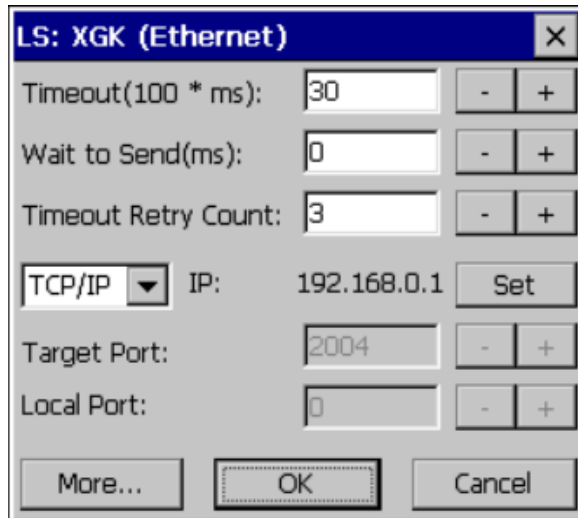

[PLC Communication Setting]

**Note**

- PLC communication setting screen may be different for each driver.
- Refer to individual PLC manual for PLC communication setting change contents.

## 5.3.2 Connection Information

You can check the connection number, PLC manufacturer, target PLC type, connection method, IP address, and timeout time set up for connection with PLC in XP-Builder.

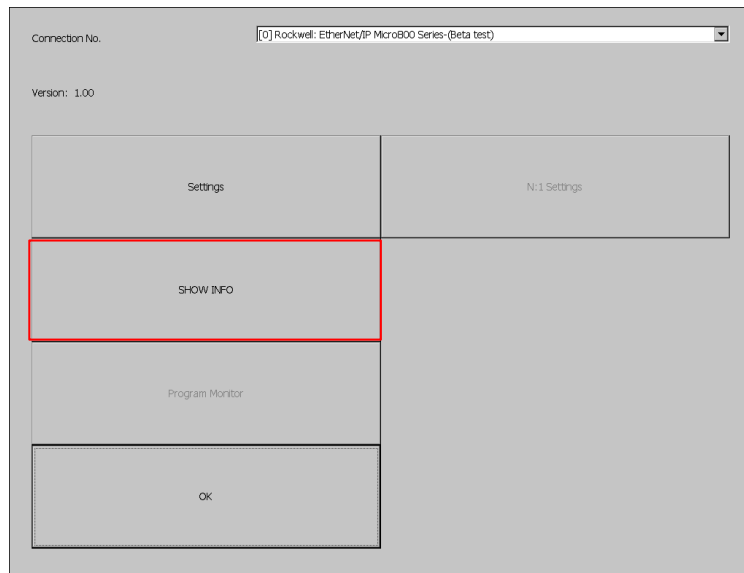

[PLC information]

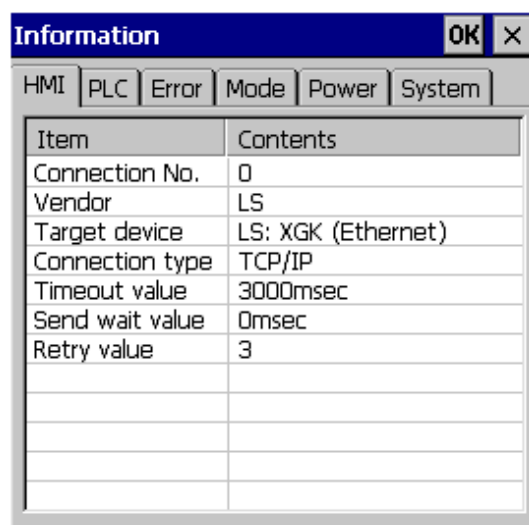

[Explanation of the dialog box]

Item	Explanation
Connection No.	Displays the communication connection number. Available from 0 to 15.
Vendor	Displays the manufacturer of the communication target device.
Target device	Displays the communication target device.
Connection type	Displays the connection method.(RS-232, RS-422, TCP/IP, ect.)
Timeout value	Displays the set timeout time.
Send wait value	Displays the transfer waiting time.
Retry value	Displays the number of retransmissions when a timeout occurs during communication.



### 5.3.3 PLC Information

You can check the CPU type, operation mode, status, version and scan time of our own PLC model and provide information only when connected with PLC.

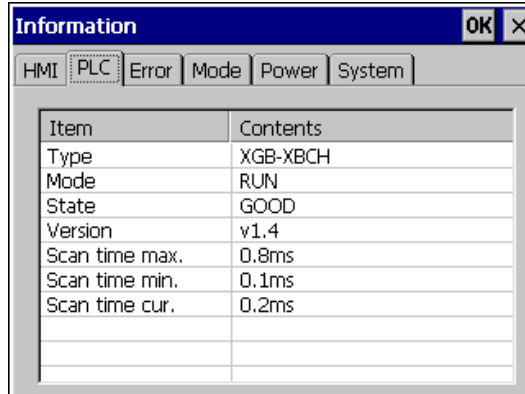

**Note**

PLC types that can view PLC information are as follows.

- MASTER-K CPU, FEnet, Cnet
- GLOFA-GM CPU, FEnet, Cnet
- XGK / XGB / XGI / XGR CPU, FEnet, Cnet

### 5.3.4 History of PLC error

You can check the PLC error history of your own PLC model.

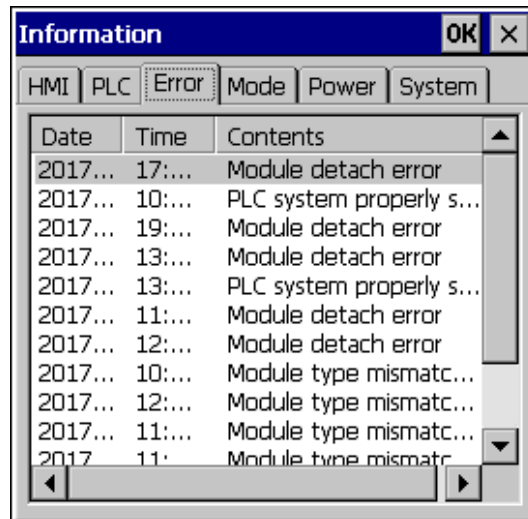

**Note**

The PLC types that can display the error history are as follows.

- The MASTER-K CPU has no error history.
- GLOFA-GM CPU, FEnet, Cnet
- XGK / XGB / XGI / XGR CPU, FEnet, Cnet

### 5.3.5 PLC Operation Mode Conversion History

You can check the PLC run / stop operation mode history of your PLC model.

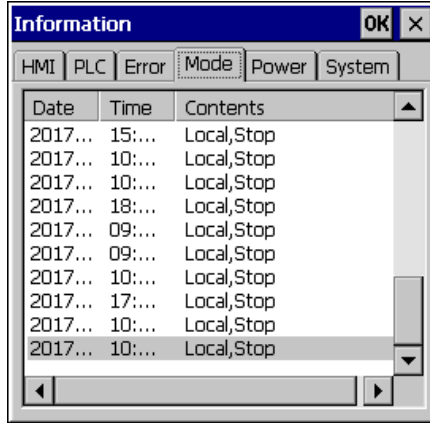

**Note**

The following PLC types are available to view the PLC operation mode switching history.

- MASTER-K CPU does not have operation mode switching history.
- GLOFA-GM CPU, FEnet, Cnet
- XGK / XGB / XGI / XGR CPU, FEnet, Cnet

### 5.3.6 History of power off of PLC

You can check the PLC power shutdown history of your own PLC type.

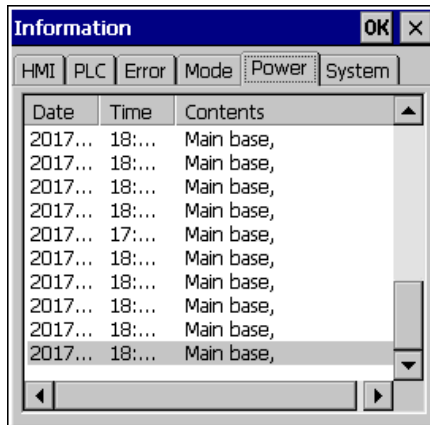

**Note**

PLC type that can view the power off history is as follows.

- MASTER-K CPU has no power off history.
- GLOFA-GM CPU, FEnet, Cnet
- XGK / XGB / XGI / XGR CPU, FEnet, Cnet

### 5.3.7 PLC System History Information

PLC system history can be checked.

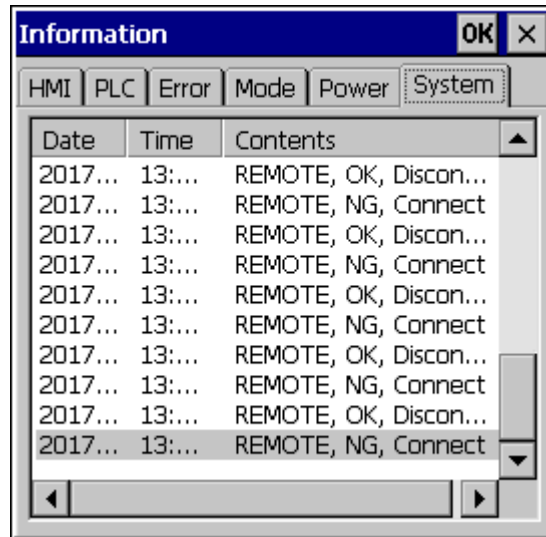

#### Note

The PLC types that can view the system history are as follows.

- The MASTER-K CPU has no system history.
- Only available with the GLOFA-GM CPU (GM4C). Other CPUs have no system history.
- XGK/XGB/XGI/XGR CPU, FEnet, Cnet

## 5.3.8 N: 1 Setting

XGT Panel supports N: 1 service which enables communication between several XGT Panels and one PLC. You can set details using the [N: 1 Settings] menu.

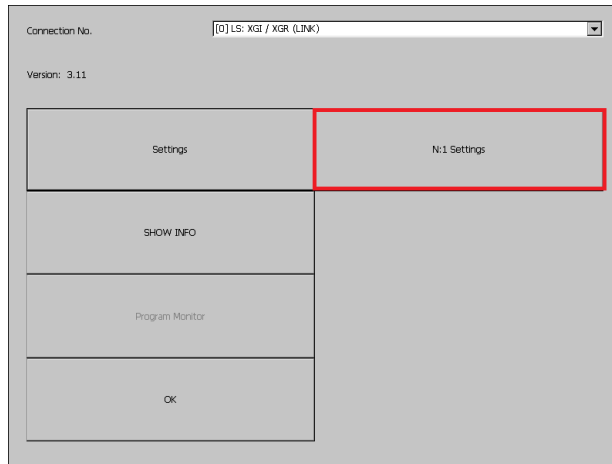

[PLC information]

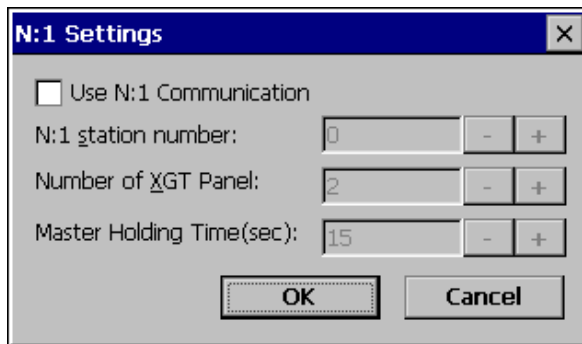

[N: 1 setting]

[Explanation of the dialog box]

Menu	Explanation
Use N: 1 Communication	N: 1 Specifies whether to perform communication.
N: 1 station number	Enter the station number of N: 1 communication.
Number of XGT Panel	N: 1 Enter the number of XGT panels on communication.
Master Holding Time	Enter the master execution time of N: 1 communication.

**Note**

For detailed setting and understanding of N: 1 communication, refer to XP-Builder's N: 1 communication manual.

### 5.3.9 Program Monitor

XGT Panel can monitor ladder of PLC XGK of LS ELECTRIC.

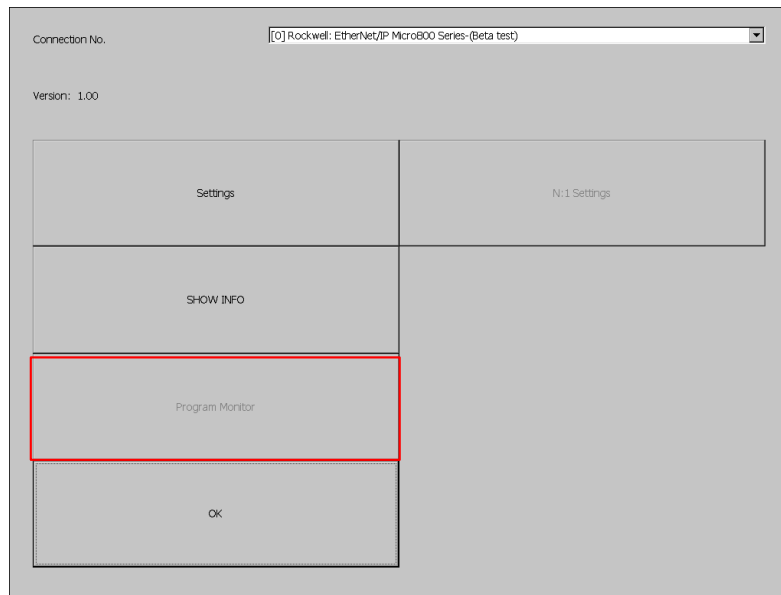

[PLC information view screen]

#### Note

- Program monitor modules must be installed via XP-Manager.
- LS: XGK / XGB CPU, Cnet, and Enet driver.
- You must specify the use of the program monitor in the project properties of XP-Builder.

## 5.4 XGT Panel Update

The functions described in this chapter are for updating the XGT Panel software. By default, XGT Panel is also optimized when downloading project file from XP-Builder. Use this function only if you need to update only the XGT Panel in particular. The software of the XGT Panel will need to be updated with the new version as new functions and enhancements are added. Refer to the following procedure.

[Method]

1. Connect XGT Panel and PC.
2. Run the XP-Builder.
- 3-1. Click [Communication] - [XGT Panel Update].
- 3-2. Click Connection Setup to select the type of XGT Panel and PC connected.
- 3-3. Click Browse and select the XP-Runtime file.

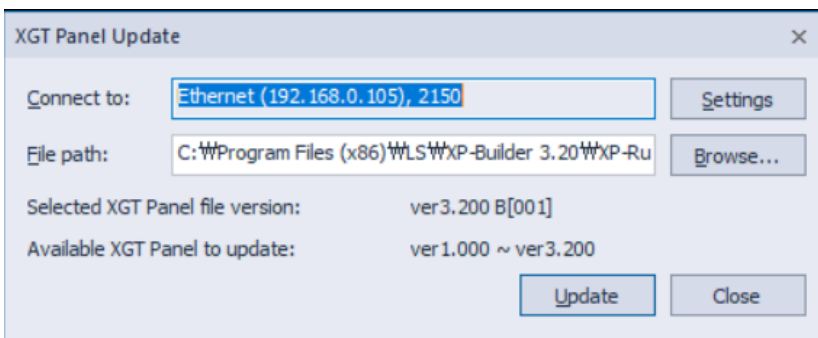

4. Select [XGT Panel Update] on the XGT Panel menu screen.
5. Click [Update] of the XGT Panel Update(No3-1).

When normal update is completed, return to XP Runtime menu screen.

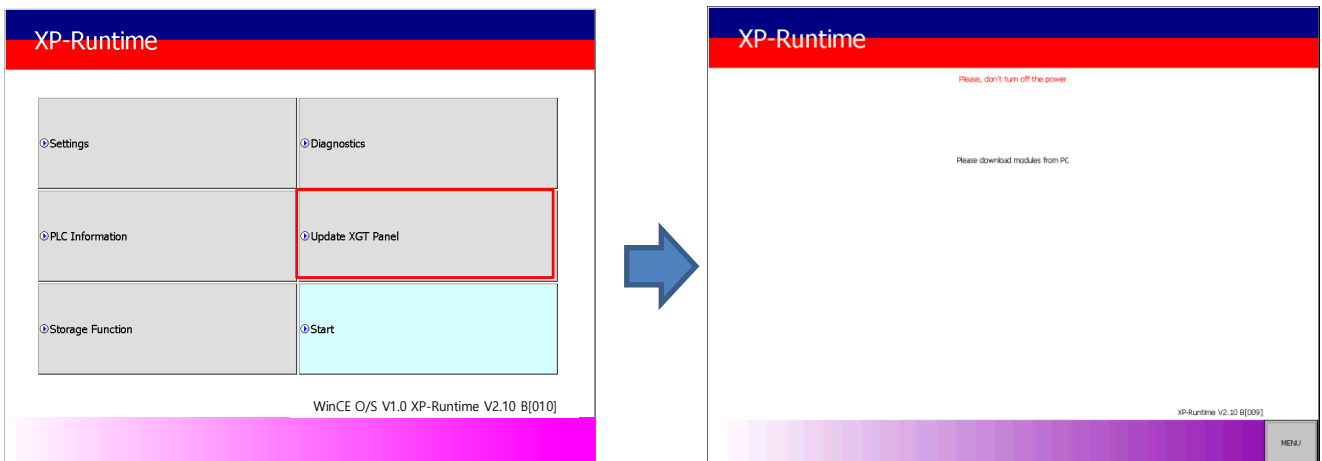

### Note

1. Do not disconnect the communication cable or turn off the device while updating the XGT Panel. XGT Panel may not update properly and may malfunction
2. Click Update XGT Panel menu and then click MENU on XP-Runtime screen to return to XP-Runtime menu screen.

## 5.5 Storage Function

### 5.5.1 Overview

Download the project edited by the user in XP-Builder from PC or upload the project backed up in the device to PC. Uploading and updating the device are usually done by connecting USB cable or Ethernet cable to XGT Panel series. You can do it through. In situations where this connection is not possible, you can use the storage device to proceed. The function description for [Storage Function] is as follows.

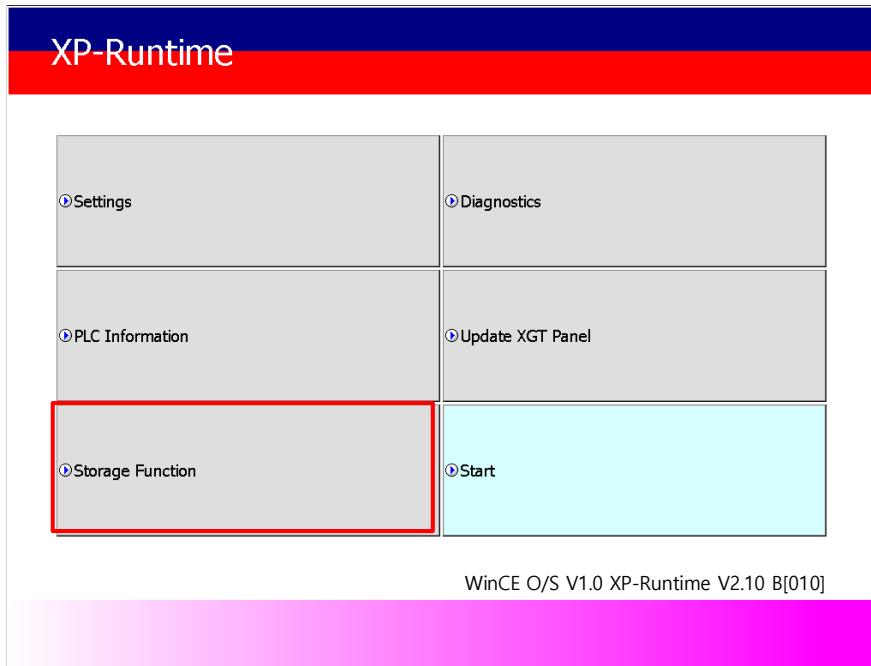

1.If you touch [Storage Function] on the menu, the following dialog box is displayed.

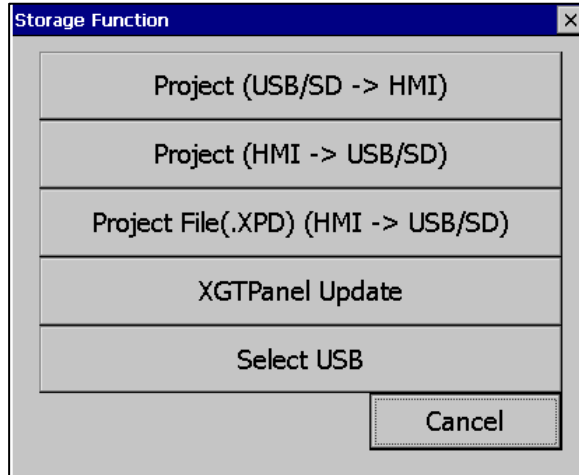

Menu	Description
Project (USB/SD -> HMI)	To download a project from an external storage device to the XGT Panel
Project (HMI -> USB/SD)	Save project from device to external storage device
Project File(.XPD) (HMI -> USB/SD)	To transfer project data backed up to an external storage device from XGT Panel
XGTPanel Update	To update the XGT Panel Software from an external storage device
Select USB	When two or more USBs are connected to the device, select the USB to save



### 5.5.2 Project Download [Project (USB/SD -> HMI)]

1. When you touch [Project (USB/SD -> HMI)] in the storage function menu, the following dialog box is displayed.

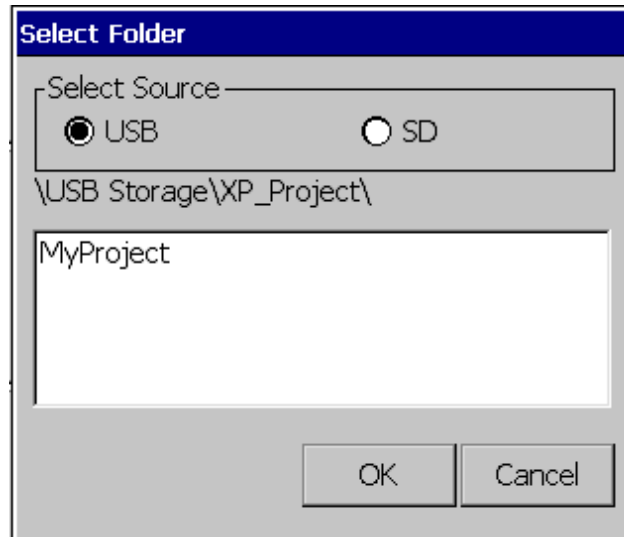

2. Project storage path of USB memory, SD card is displayed as below.

- \USB Storage \ XP\_Project \
- \SD Storage \ XP\_Project \

If you want to download a project using a storage device, it must be stored in the directory in the above path.

3. Select one of the directory listings.

4. Touch the [OK] button to start the download.

### 5.5.3 Project Upload [Project (HMI -> USB/SD)]

1. When you touch [Project (HMI -> USB/SD)] in the storage function menu, the following dialog box is displayed.

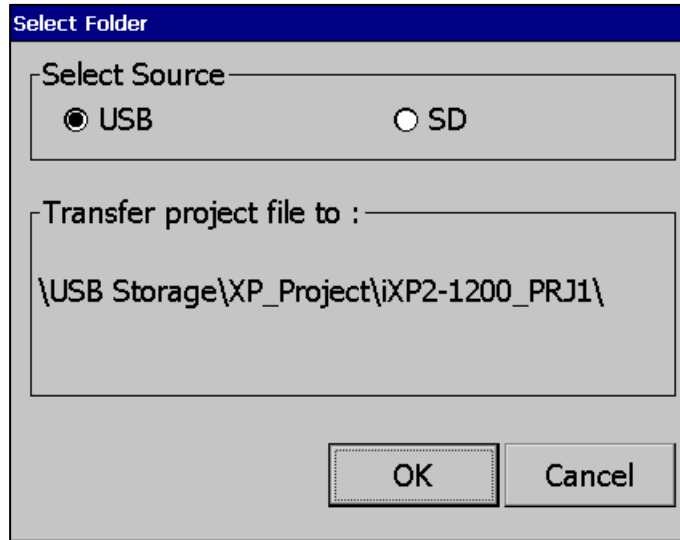

2. Project storage path of USB memory, SD card is displayed as below..

※ The folder name under USB or SD Storage\\XP\_Project\\ is automatically set to PRJ1 after the device type name.

(The project to be saved afterwards automatically increases by 1 in the order of PRJ2, PRJ3.)

EX)

- \\USB Storage\\XP\_Project\\iXP2-1200PRJ1\\

- \\SD Storage\\XP\_Project\\iXP2-1200PRJ1\\

3. Touch the [OK] button to transfer the project backup file in the machine to the path of the selected storage device.

4. It is possible to transfer directly between the same devices by using the project saved in the storage device.

(This function is applied only to the same model and is not downloaded to a different model than the uploaded project.).

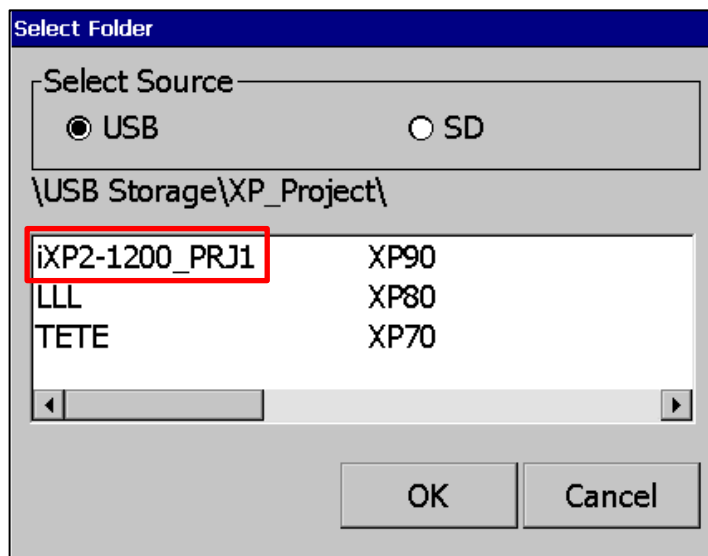

### 5.5.4 Project Upload Project File(.XPD) (HMI -> USB/SD)

1. If you touch [Project File (.XPD) (HMI -> USB/SD)] in the storage function menu, the following dialog box is displayed.

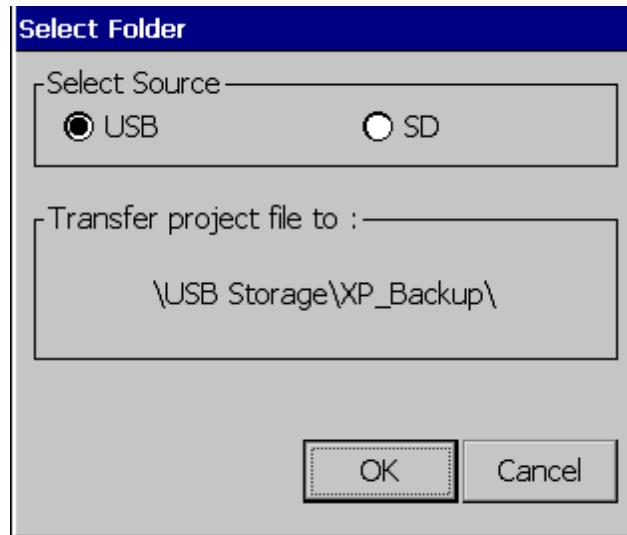

2. The upload path of USB memory and SD card is displayed as below.

- \\USB Storage \\ XP\_Backup \\
- \\SD Storage \\ XP\_Backup \\

3. Touch the [OK] button to transfer the project backup file in the machine to the path of the selected storage device.
4. The project backup file must be downloaded to download the project backup file when downloading the project.  
If not selected, the project backup file is not stored in the device and therefore cannot be transferred to the storage device.

### 5.5.5 Updating the device using a storage device

1. If you touch [Update XGT Panel] in the storage function menu, the following dialog box will be displayed.

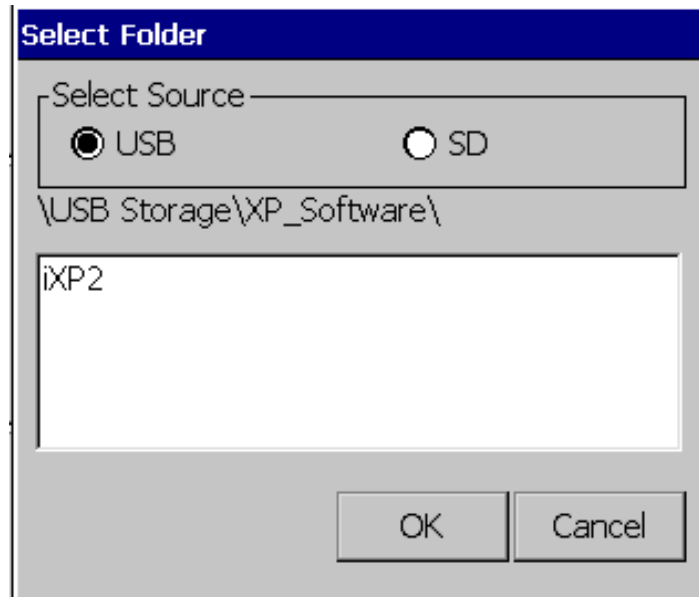

2. The path of USB memory, SD card is displayed as follows.

- \USB Storage \ XP\_Software \
- \SD Storage \ XP\_Software \

If you want to update the device using an external storage device, the XGT Panel Software file is in the directory in the above path

It must be saved.

3. Touch the [OK] button to update the device with the XGT Panel Software stored in the specified path.

### 5.5.6 Storage device selection function [Select USB]

1. When multiple USB devices are connected to the XGT Panel, you must select a device for uploading, downloading, or backing up projects. You can change your selection at any point during a project.

To select a USB storage device:

In the XGT Panel main menu, touch[Storage Function], then Touch [Select USB]

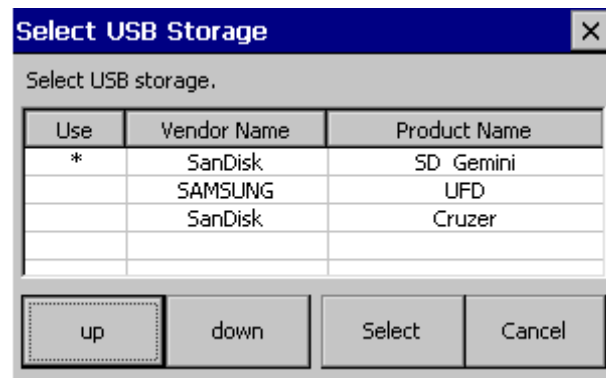
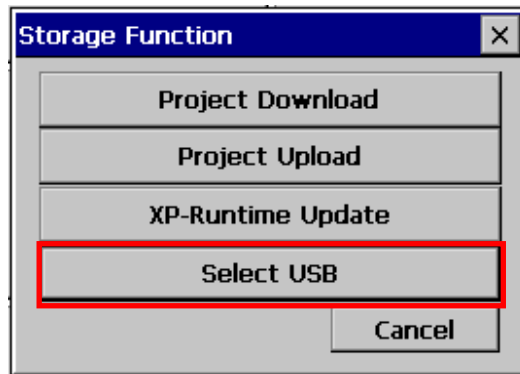

2. Select device from the list of connected devices

- Use: The selected device is indicated with an asterisk(\*).
- Vendor Name: The device manufacturer
- Product Name: The device name
- Up/down: Move to the next or previous item
- Select: Save your selection
- Cancel: Exit without saving changes

5.5.7 Storage device selection function during monitoring

1. To select a storage device while monitoring a project, on the XGT Panel, touch [Start] to open the Select USB Storage window. Select a USB device and touch [Select].

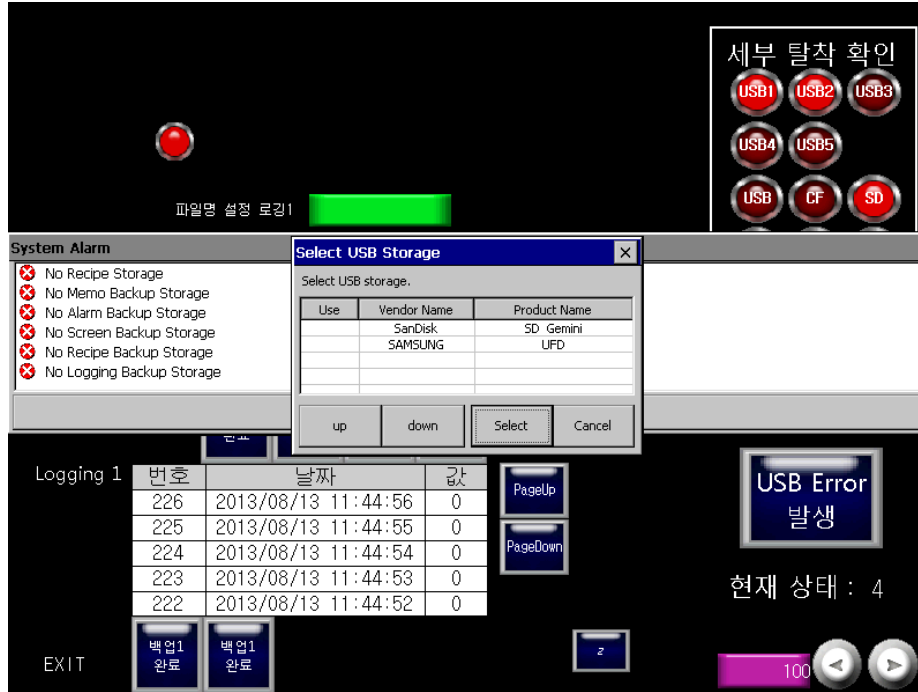

2. To select a storage device from the status bar, touch [USB].



3. If the selected device is disconnected or if another device is connected, the Select USB Storage window appears again.

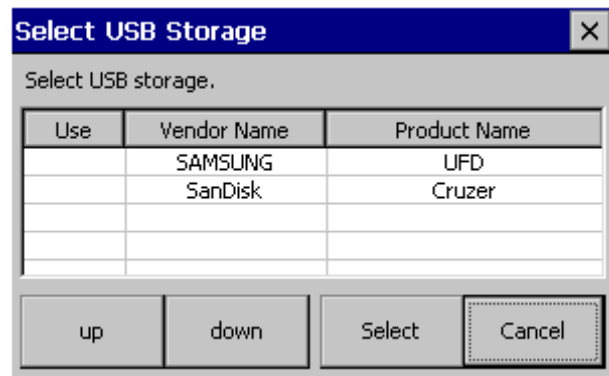

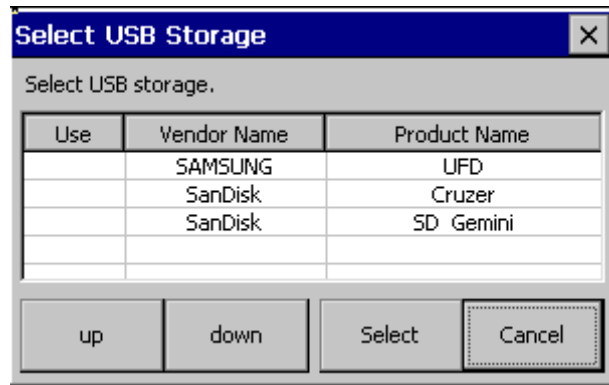
**Remark**

- (1) Do not remove or turn off the selected USB device while running a project. Project data may be corrupted and cause the project to malfunction.
- (2) Do not erase or move the directory or folders on the USB device. Doing so may cause data to be corrupted or the project to malfunction.
- (3) When removing an SD Care memory, turn on the safe removal switch on the back of the panel and remove the device only after the switch lamp turns off. Failure to do so may cause the device to be unrecognized when you reconnect it.
- (4) When you reconnect a device, allow at least three (3) seconds to establish the connection. Failure to do so may cause the device to be unrecognized when you reconnect it.
- (5) When one USB device is connected, turning on the power to the panel will set the USB device as the main storage device automatically.
- (6) When connecting multiple devices, the first device connected is set at the main storage device automatically. However, removing devices does not change the selected storage device automatically. You must reselect the main storage device.

## Chapter 6 Backup files by using Storage Devices

This chapter describes the management functions for external storage devices that store backup data of logging, recipe, and screen images.

- (1) XGT Panel can back up logging, recipe, screen image data to USB storage device according to the settings set in XP-Builder.
- (2) If there is no capacity to be backed up on the specified storage device, the existing data is deleted according to the settings set by XP-Builder, and the backup process or backup is stopped.
- (3) The XP-Builder monitors whether or not the external storage device specified as the backup device is detached.

### 6.1 Path Structure in case of File Backup

Backup path structure of logging, recipe, and screen image is as follows.

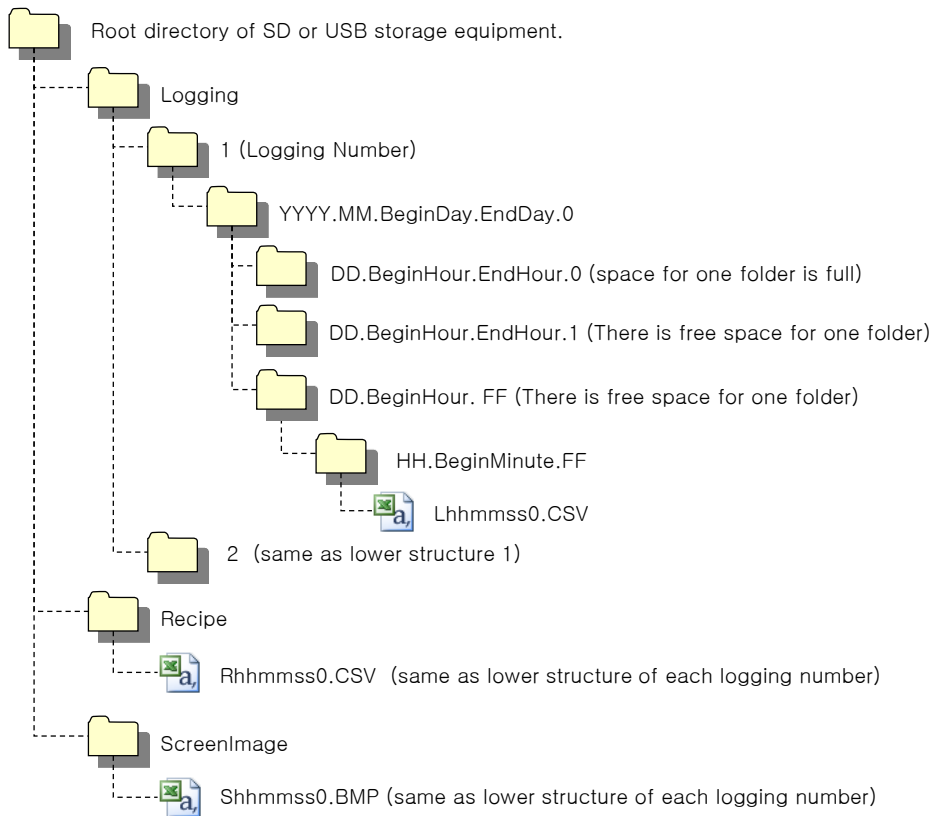



### 1. Path structure in case of logging backup

- (1) Directory named 'Logging' is created under the root directory of USB equipment
- (2) The directory whose name is logging number is created under Logging directory.
- (3) The directory whose name is year, month is created under Logging number directory.
  - (a) Includes day directory under
  - (b) Up to 500 day directories can be created.
  - (c) Name of year, month directory includes the firstly created day information under its directory  
Ex) In case directory is created in 2010, October and includes directory since 15th under, directory's name is  
: 2010.10.15.FF  
FF at end means the directory can save more data created in 2010, October (currently, the number of lower directory is 500 or less)
  - (d) In case month is changed, changes directory name to day information of last created day directory.  
Ex) In case month becomes November from October and directory from 15th directory to 30th have been created in 2010, October directory.  
: 2010.10.15.30.0
  - (e) Though month is not changed, in case the number of day directory under year, month directory is 500 or above, directory name is changed into name including day information of last created day directory.  
Ex) In case the number of directory from first to 15th is 500 or above in the directory created in 2010, October.  
: 2010.10.01.15.0
  - (f) In case there is the year, month directory having same start day and end day when changing directory's name due to over 500 day directories or change of month, last digit index number increases.  
Ex) In case there are three year, month directories that are having over 500 day directories created in October first and 2010 year October directory  
: 2010.10.01.01.0  
: 2010.10.01.01.1  
: 2010.10.01.01.2
- (4) Day directory is created under year, month directory
  - (a) Hour directory is created under day directory
  - (b) Day directory can have up to 500 hour directory
  - (c) Name of day directory includes not day information but also hour information of first created hour directory
  - (d) Relation between day directory and hour directory is same as relation between year month directory and day directory.
- (5) Directory whose name includes hour information is created under day directory.
  - (a) Hour directory includes backup file under
  - (b) Hour directory can include up to 500 backup file
  - (c) Name of time directory include not only hour information but also minute information of first created file under
  - (d) Relation between hour directory and backup file is same as relation between year, month directory and day directory.
- (6) Name of logging backup file includes the created hour, minute, second information.
  - (a) Backup file is created in CSV format.
  - (b) File name start with 'L' meaning logging and includes hour, minute, second, index information
  - (c) In case backup file is created at the same time in terms of second, index information at the end of file name increases.

### 2. Path structure in case of recipe backup

- (1) Directory named 'Recipe' is created under USB storage equipment root directory.
- (2) Year, Month directory is created under Recipe directory
- (3) The lower directory structure is same as that of logging backup path structure.
- (4) Name of recipe backup file includes the created hour, minute, second information.
  - (a) Backup file is created in CSV format.
  - (b) File name start with 'R' indicating recipe and includes hour, minute, second, index information.
  - (c) In case backup file is created at the same time in terms of second, index information at the end of file name increases.

### 3. Path structure in case of screen backup

- (1) Directory named 'Screen Image' is created under USB storage equipment root directory.
- (2) Directory whose name is year; month is created under Screen Image directory.
- (3) The lower directory structure is same as that of logging.
- (4) Name of screen image backup file includes hour, minute, second information.
  - (a) Backup file is created in bitmap format.
  - (b) File name starts with 'S' and includes hour, minute, second, index information.
  - (c) In case backup file is created at the same time in terms of second, index information at the end of file name increases.

### 4. Structure of path at memo backup

- (1) 'Memo' directory will be formed at the sub route directory of USB storage device.
- (2) Directory in the name of Year and Month will be formed below the Memo Directory.
- (3) Structure of directory thereafter is same as that of logging backup route.
- (4) Memo backup file has the name made of hour/minute/second when it was created.
  - (a) Backup file is created in the type of bitmap.
  - (b) File name starts with 'M' that represents the screen image, which includes the index information of hour, minute, and second thereafter.
  - (c) If the backup file is created at the same time up to the second, it increases the index information at the end.

### 5. Structure of path at live image recording

- (1) 'Movie' directory will be formed at the sub route directory of USB storage device.
- (2) Recorded live image is stored below the Movie Directory.
- (3) Live image file has the name made of year/month/date/hour/minute/second information when it was created.
  - (a) Backup file will be created in AVI type. H.264 and MP3 were used for Video CODEC and Audio CODEC respectively.
  - (b) File name starts with 'MOV' that represents screen image, which includes data and hour information thereafter.
  - (c) Live image can be stored up to the number 1,000 files. This number can be designated at the special device settings of XP-Builder.

### 6. Structure of path when Blue Screen of camera image and live image is created

- (1) 'MovieStill' directory will be formed at the sub route directory of USB storage device.

- (2) Recorded live image will be stored below MovieStill directory.
- (3) Blue screen image file has the name made of year/month/date/hour/minute/second information when it was created.
  - (a) Backup file will be created in JPG type.
  - (b) File name starts with 'STL' that represents screen image, which includes data and hour information thereafter.
  - (c) Live image can be stored up to 1,000 files. This number can be designated at the special device settings of XP-Builder.

### Remark

- (1) When changing device time, in case of changing current time into after time, we guarantee the normal operation. But in case of changing current time into early time, we don't guarantee the normal operation. In this case, you have to delete directory including the changed hour and its lower directory for normal operation. For example, if you change time from December 10<sup>th</sup> to December 5<sup>th</sup>, you have to delete year, month directory created in December 10<sup>th</sup> and restart the device
- (2) Sorting by project is not supported for each logging, recipe, screen image. For example, there are no.1, 2, and 3 logging groups in the project A. And in case each logging group backups the file, 1, 2, 3 directories are created and each data is saved under each directory. Then, in case file backup occurs in the project B having no.1, 2 logging group, backup file is created in same directory of project A. In this case, you have to sort the backup files of project A and B based on the created time.

### 6.2 Operation Setting when there is no space for Backup

You can designate in the XP-Builder whether to cancel the backup or delete the oldest backup file and execute backup when there is no space in the storage equipment.

[Project Property Setting -> Storage Settings -> Backup Storage -> Delete old file if disk full]

#### 1. In case of backup, deleting the oldest data

- (1) In case there is no space for backup, searches the oldest year, month directory under Logging, Recipe, Screen Image. (But in case of Logging, finds under Logging number directory. That is, when executing backup about Logging number 2, in case there is no backup data in Logging number 2 directory and there is data only in logging number 1, data of logging number 1 is not searched/deleted.)
- (2) Searches the oldest day directory under the oldest year, month directory.
- (3) Searches the oldest hour directory under the oldest day directory.
- (4) Deletes the oldest backup file under the oldest hour directory.
- (5) Checks the space and if more space is necessary, the above steps of (1) ~ (4) are repeated and checks the space.
- (6) When deleting file, in case all data in time directory are deleted, relevant hour directory is deleted.
- (7) When deleting hour directory, in case all hour directories in day directory are deleted, relevant hour directory is deleted.
- (8) When deleting day directory, in case all day directories in year, month directory are deleted, relevant year, month directory is deleted.

#### Remark

- (1) In unknown directory or file (user file or directory), searches the oldest thing among normal backup files except unknown directory or file.
- (2) In case there is nothing except user data in now searched directory, backup operation fails. XGT Panel can't delete user data, at this point, operation stops.

### 6.3 Monitoring Connection Status of External Storage Equipment

XGT Panels monitors connection status about external storage equipment designated when setting backup path in XP-Builder. The following figure is backup path specified in XP-Builder.

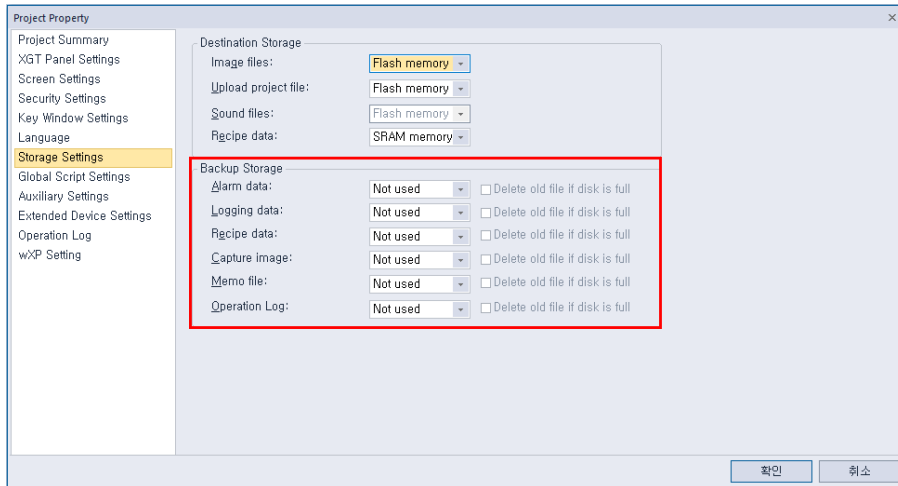

In order to use this monitoring function, you have to set about system alarm window, and then the project should be downloaded.

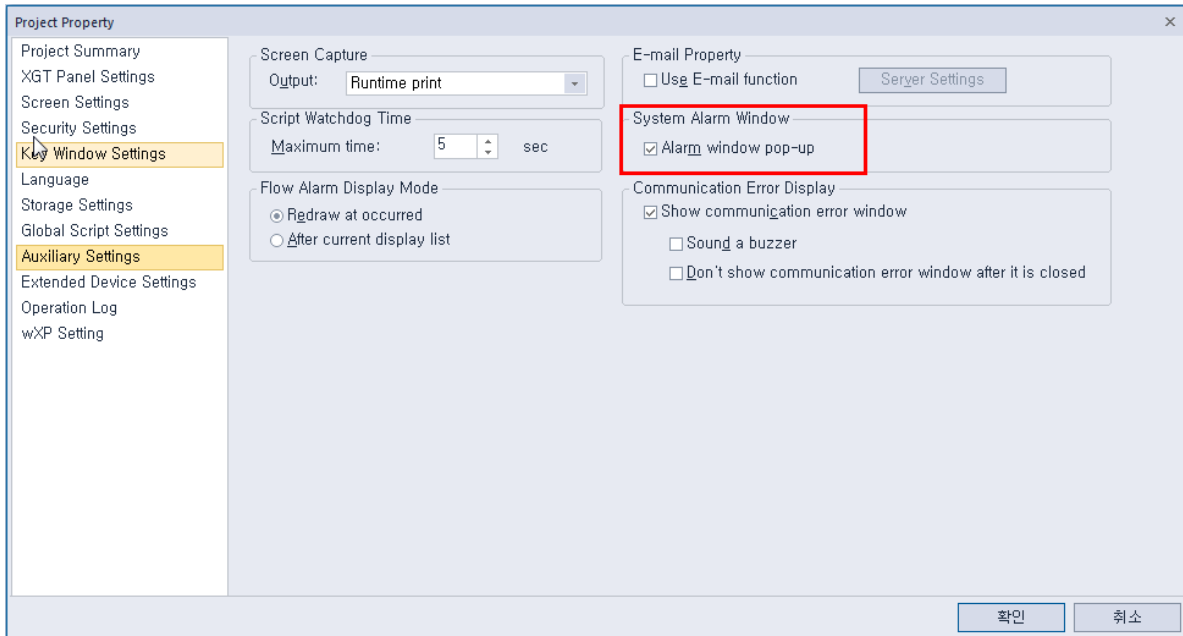

## Chapter 6 Backup files by using Storage Devices

In case USB storage equipment is removed during operation after setting the path for saving Logging backup file as USB storage equipment and downloading the project into device, the designated system alarm (HS951.0) is set. In case storage equipment is equipped again, alarm is reset.

In case USB storage equipment is removed during operation after setting the path for saving Recipe backup file as USB storage equipment and downloading the project into device, the designated system alarm (HS951.1) is set. In case storage equipment is equipped again, alarm is reset.

In case USB storage equipment is removed during operation after setting the path for saving Screen Image backup file as USB storage equipment and downloading the project into device, the designated system alarm (HS951.2) is set. In case storage equipment is equipped again, alarm is reset.

Internal address of the designated system alarm can be checked in XP-Builder as follows.

	Device	Data Type	Description
1	HS950.0	BIT	NVRAM Low Battery Warning
2	HS950.1	BIT	NVRAM Invalid Data Warning
3	HS951.0	BIT	No Logging Backup Storage
4	HS951.1	BIT	No Recipe Backup Storage
5	HS951.2	BIT	No Screen Backup Storage
6	HS951.4	BIT	No Printer
7	HS950.8	BIT	USB Over Current Warning
8	HS951.3	BIT	No Alarm Backup Storage
9	HS951.5	BIT	No Memo Backup Storage
10	HS100.2	BIT	Failed to load XPLink parameter
11	HS950.9	BIT	RS232C Over Current Warning
12	HS950.A	BIT	VM Module Over Current Warning
13	HS950.B	BIT	Extended Module Over Current Warning
14	HS951.6	BIT	No Movie Backup Storage
15	HS951.7	BIT	No Movie Still Image Backup Storage
16	HS951.8	BIT	No Sound File Storage
17	HS951.9	BIT	No Recipe Storage
18	HS950.6	BIT	SD card has been incorrectly recognized
19	HS950.7	BIT	CF card has been incorrectly recognized
20	HS950.5	BIT	Storage device has been incorrectly recognized
21	HS950.C	BIT	Out of System Memory
22	HS950.F	BIT	Thread Pool is full
23	HS951.A	BIT	No Operation Log Backup Storage
24	HS092.2	BIT	Number of alarms in SRAM has reached limits.

## Chapter 7 Maintenance

To keep the XGT Panel best, examine the XGT Panel.

### 7.1 Maintenance

Because an error may be developed by environment, the periodic maintenance is needed. You should check the following categories once or twice every 6 months.

Maintenance category		Criterion	Action
Power		Within the power change range (Within -15% / +10%)	Modify the source of electric power in order to be in the fluctuation range of a permissible voltage.
Environment	Operating temperature	0 ~ + 50 °C	Modify the operating temperature and humidity to be proper.
	Operating humidity	10 ~ 85%RH	
	Vibration	No vibration	Use the anti-vibration rubber and make a count measure.
Getting loose of power terminal		There is no unwinding	Screw the unwound terminal.
Getting loose of communication connector		There is no unwinding	Screw the unwound terminal.
Reserved part		Amount of reserved part and reservation Check the status	Refill the insufficiency and improve the reservation.
Gasket installation status		No gap between the gasket and panel.	Replace gasket or affix brackets firmly
Gasket status		No damage or deterioration	Replace gasket
Front Panel status check		No damage or deterioration	Use a dry cloth to remove dust and foreign matter.

### 7.2 Daily Maintenance

Check the followings daily.

Maintenance category	Maintenance contents	Criterion	Action
Mounting status	Check the brackets	Should be mounted firmly	Retighten screws
Power terminal status	Loose terminal screws	Not loose	Retighten screws
	Reduce the distance between compressed terminals.	Keep the proper distance.	Correction
Communication connector status	Unwinding of fixed screw	Not loose	Retighten screws
Indication LED	Check the lighting	Blue LED should be turned on	Refer to the Appendix 1.
Touch panel surface state	Check the touch panel	No pollution such as water drops or oil	Surface wiping

### 7.3 Periodical Maintenance

Check the followings once or twice every six months and take measure.

Maintenance category		Maintenance method	Criterion	Action
Environment	Surrounding Temperature	Measure through Temperature /Hygrometer Measure of corrosive gas	0 ~ 50 °C	Modify it to meet the general standard. (Environment standard in the panel)
	Surrounding Humidity		10 ~ 85%RH	
	Surrounding pollution degree		No corrosive gas.	
XGT Panel Status	Unwinding, swing	Move XGT Panel	Fixed firmly	Retighten screws
	Dust, foreign matter adhesion	Visual check	Not loose	Use a dry cloth to remove dust and foreign matter.
Connection status	Looseness	Retighten screw with Screwdriver	Not loose	Retighten screws
	Reduce the distance between compressed terminals.	Visual check	Keep the proper distance.	Correction
	Loose connectors	Visual check	Not loose	Wind the fixed screw of connector
	Loose brackets	Retighten screw with Screwdriver	Not loose	Retighten screws
Power voltage maintenance		Check the power voltage of input terminal of power by test	AC: 100~240V DC: 24V	Supply power modification
Battery		Check when battery is exchanged and voltage drop is indicated. (It is expressed by system alarm)	<ul style="list-style-type: none"> <li>• Check the total of power stoppage time and guarantee duration</li> <li>• There is no battery voltage drop indication</li> </ul>	If guarantee duration is exceeded even though there is no battery voltage drop indication, change the battery.
LCD Backlight maintenance		Visual check	Check the guarantee duration	When error occurs, change the backlight.
Touch status	Touch Screen error	Visual check	No damage or Scratches and Pollution	When error occurs, change the Touch Panel
	faulty touch pad	Visual check	No damage or Scratches /contamination	Change the touch pad in case of an abnormality



Maintenance category		Maintenance method	Criterion	Action
	Front sheet damage and deformation	Visual check	<ul style="list-style-type: none"><li>• Damage or scratches /contamination nonexistent</li><li>• No front sheet deformation</li></ul>	Replace front sheet in case of an abnormality

## Remark

- (1) Battery exchange time is expressed by alarm. System alarm is expressed when system alarm category is set at the XP-Builder as follows.

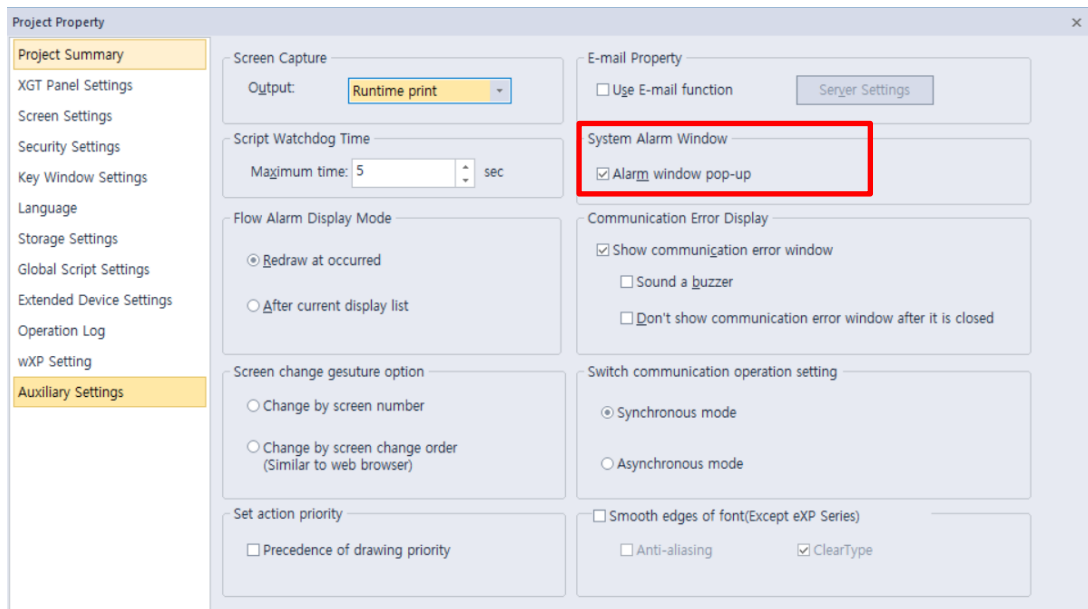

- (2) Replace Battery With Hitachi Maxell, Part No. CR2032 Only. Use of another battery may present a risk of fire or explosion. See User Manual for safety Instructions.

 **WARNING:** Battery may explode if mistreated. Do not recharge, disassemble or dispose of in fire.

- (3) As the iXP2 model has the integrated LCD and backlight, the LCD should be replaced when the life is over or it is out of order.

- (4) One of the ESD prevention measures, please use after wiping with a damp cloth.

## Chapter 8 EMC Standard Certification

### 8.1 Requirement for EMC Standard Certification

EMC command is regulated on “It doesn’t produce the Strong electromagnetic waves: Emission” and “It is not affected by electromagnetic wave from external: Immunity”. The following is describing the contents to meet the EMC command when configuring the system by using the XGT Panel. This is a summary document for the request and standard which our company has obtained from EMC but we don't assure that all devices manufactured according to these contents are not suitable for the below standards. The final manufacturer needs to finally judge about the fitness method or fitness judgment of EMC command.

#### 8.1.1 CE Standard Certification

In case of XGT Panel, the EN61000-6-4, EN61000-6-2, EN61000-3-2, and EN61000-3-3 of CE standards were applied.

Applied Standards		Results
1. Emission		
Conducted Disturbance	EN61000-6-4:2007 / A1 : 2011	C
Radiated Disturbance	EN61000-6-4:2007 / A1 : 2011	C
Harmonic Current Emission	EN61000-3-2:2014	N/T
Voltage Change, Fluctuations and Flicker	EN61000-3-3:2013	N/T
2. Immunity		
Electrostatic Discharge	EN61000-6-2:2005 / AC : 2005	C
	EN61000-4-2:2009	
Radio-Frequency Electromagnetic Field	EN61000-6-2:2005 / AC : 2005	C
	EN61000-4-3:2006 / A1 : 2008 / A2 : 2010	
Fast Transient	EN61000-6-2:2005 / AC : 2005	C
	EN61000-4-4:2004 / A1 : 2010	
Radio-Frequency Continuous Conducted	EN61000-6-2:2005 / AC : 2005	C
	EN61000-4-6:2009	
Power-Frequency Magnetic Fields	EN61000-6-2:2005 / AC : 2005	N/T
	EN61000-4-8:2010	
Surges	EN61000-6-2:2005 / AC : 2005	C
	EN61000-4-5:2006	
Voltage Dips and Interruptions	EN61000-6-2:2005 / AC : 2005	N/T
	EN61000-4-11:2004	
C=Comply    NC=Not Comply    N/T=Not Tested    N/A=Not Applicable		

Directive:

Electromagnetic Compatibility Directive 2014/30/EU amended by the Directive 93/68/EEC



### 8.1.2 KC Standard Certification

The XGT Panel acquire the electromagnetic fitness registration (KC specification) certified by wave laboratory under information-communication part.

A grade device

This device acquires KC for industrial use.

If device is not purchased properly, exchange it to device for home use.



## 8.2 Requirement for Low Voltage Command Suitability

It is required to get the needed Stability for the device operated at AC50~1000V, DC75~1500V's power. The following describes attention about installation and wiring for the suitability when using the XGT Panel. Though the following data is made by requirement of regulation and standard, we don't guarantee that all devices are suitable for the above command. The method to be suitable for the EMC command and judgment of suitability should be finally made by device manufacturer himself.

### 8.2.1 Standard Certification for XGT Panel

XGT Panel is according to the EN61131-2:2007 (stability of device used in the measure, control laboratory).

### 8.2.2 Selection of XGT Panel

- (1) iXP2-08xxA, iXP2-10xxA, iXP2-12xxA, iXP2-15xxA

Power module with rated input voltage of AC100 / 240V has hazardous voltage (voltage of 42.4V peak or more) inside. Therefore, the CE marked product is reinforced and insulated between the internal primary and secondary

- (2) iXP2-08xxD, iXP2-10xxD, iXP2-12xxD, iXP2-15xxD

I/O modules with a DC 24V rating or less are out of the low voltage command target range.

## Appendix 1 Troubleshooting

### 1. Type of Problems

It classifies problems from XGT Panel including an indicated figure, indication of the object, and problems appeared when downloading. Refer to the following chart.

Classification of problem	Description
Problem when starting	Malfunction when starting. ☞ <b>Please refer to the 2. Problem when starting.</b>
Problem after the monitor on	In case that there is no reaction when touching. ☞ <b>Please refer to the 3. Problem after the Monitor on.</b>
Display problem of figure and object.	In case that the figure or object is different from when editing. ☞ <b>Please refer to the 4. Indication problem of figure and object.</b>
Communication problem	In case that communication is not executed properly. ☞ <b>Please refer to the 5. Communication problem.</b>
USB Removal of Memory Card	In case that USB device is not working for a while when USB memory is removed. ☞ <b>Please refer to the 6. USB Removal of Memory Card</b>
External memory recognition problem	If external storage device such as USB, SD card is not recognized ☞ <b>Please refer to the 7. External Memory Recognition.</b>
Touch recognition problem	If the touch is not recognized normally ☞ <b>Please refer to the 8. Touch recognition.</b>
Error message when executing program	In case that an error message occurs when operating the XGT Panel. ☞ <b>Please refer to the 9. Error message when executing program.</b>

## 2. Problems when Starting

<b>Question</b>	Why does black screen show up when turning on the device?
<b>Phenomenon</b>	When turning on the device, black screen shows up and the booting is impossible.

**< Cause >**

- (1) Because the device is not set as a booting mode.
- (2) Black screen may appear because of malfunction of backlight.

**<Solution>**

- (1) Because the device is not set as a booting mode, the above problem can occur.  
Check whether No. 5 switch at DIP switch in the back of the device is in B direction or not.  
B direction is a booting mode.

When is the color of LED changed?  
Please check the followings.

Display color	Contents
BLUE	Power is supplied to XGT Panel

<b>Question</b>	When applying the option, 'Go to Screen after boot up', it displays "Failed to load image files" as the monitoring has not been started.
<b>Phenomenon</b>	After storing images in the USB storage device and then selecting the option "Go to Screen after boot up" in the start menu, in case when re-permitting the power of the equipment, the message like "Failed to load image files" is displayed and the monitoring is not started.

**<Cause>**

- (1) In case when it is connected with the USB storage device, the recognition of the USB is delayed.

**<Solution>**

- (1) In case when the recognition speed is delayed due to the characteristics of the USB storage device, remove the USB storage device and then reinstall it.

<b>Question</b>	When the power is re-permitted, the USB storage device (or USB mouse) is not recognized.
<b>Phenomenon</b>	When the USB storage device was initially installed, it was normally recognized. However, it is not recognized after the power is re-permitted.

**<Causes>**

- (1) Due to the option of the 'Reset USB Power' of the equipment, there could problems in the recognition process.
- (2) Depending on the USB storage device, it may not be smoothly recognized.

### <Solution>

- (1) If the power initialization option (“Reset USB Power”) of the equipment is selected, cancel the selection and then permit the power again. The “Reset USB Power” option is an additional function to improve the initialization of the storage device with slow recognition speed or low recognition ratio. Depending on the characteristics of the storage device, however, the power initialization can be an obstacle to the initialization work. Thus, depending on Phenomenon, select what has higher recognition ratio by properly using the power initialization option.
- (2) Depending on the characteristics of the storage device, it may not be recognized. Use another USB storage device showing higher recognition ratio.

### 3. Problems after the Monitor on

<b>Question</b>	When touching the screen it reacts in a different area or it may not react at all?
<b>Phenomenon</b>	When touching the screen it reacts in a different area or it may not react at all.

**< Cause >**

- (1) Touch's Calibration setting is not proper.
- (2) Touch panel may be a break down.

**<Solution>**

- (1) Redo Calibration setting about touch. Refer to the [Device manual Ch.4.1 Touch Calibration].
- (2) If you can't go to setting menu, connect mouse to USB port and use mouse.

<b>Question</b>	Buzzer does not sound.
<b>Phenomenon</b>	When pressing buzzer, buzzer does not sound.

**< Cause >**

- (1) When that the switch operates but the buzzer doesn't sound, the buzzer is set as no sound.
- (2) If the switch doesn't work too, it seems that some error occurs in the touch function.

**<Solution>**

- (1) Redo environment setting for buzzer to sound. Refer to the [device manual Ch.4.7 Environment Setting].
- (2) After setting to use buzzer, check whether the buzzer sounds or not in the 1)'s setting windows.

<b>Question</b>	Lack of system memory system alarm occurs.
<b>Phenomenon</b>	After the system alarm about the lack of system memory occurs, XGT Panel itself closes the monitoring and then moves to the start menu in unspecific time without user's operation.

**<Causes>**

- (1) The memory usage could be exceeding 95%.
- (2) The memory usage can be a bit increased when floating pop-up windows or moving to several screens during monitoring. In case when the number of image used for project is a lot, the memory usage can more easily reach the limit. In this case, XGT Panel closes the monitoring by itself and then takes an action to secure the memory again.

**<Solution>**

- (1) In case of using vector image instead of raster image, the memory share can be reduced. In the graphic library of XP-Builder, the image group marked as OOO\_R is the raster image group while the image group marked as OOO\_V is the vector image group.
- (2) In case when the monitoring is closed down due to the increase of the memory share in spite of the image change operation, contact the A/S center close by.



<b>Question</b>	After continuously adding projects to the screen, and adding/editing objects, the operation speed has been slowed down.
<b>Phenomenon</b>	After adding projects to the screen and also adding/editing objects, it feels like the operation speed of XGT Panel gets slowed down.

### <Causes>

- (1) The amount of image used for projects is big.
- (2) In order to increase the screen operation speed, XGT Panel maintains the used images in the memory in advance. Since the memory resource has limitation, they cannot be maintained in the memory once the amount of image exceeds a certain limit. Whenever they are needed, thus, they are read from the file system and then expressed on the screen. This could be the reason why the screen operation speed gets slowed down.

### <Solution>

- (1) In case of using vector image instead of raster image, the memory share can be reduced. In the graphic library of XP-Builder, the image group marked as OOO\_R is the raster image group while the image group marked as OOO\_V is the vector image group.
- (2) In case when there is no proper vector image, the desired image can be composed by using various functions of figures (circle, square, straight line and etc.).
- (3) Removing unnecessary background screen, the screen is composed by applying the background colors.

## 4. Display Problem of Figure and Object

<b>Question</b>	The shape of object is not shown or the number or character value which has to be shown is not shown
<b>Phenomenon</b>	The shape of object is not shown or the number or character value which has to be shown is not shown.

**<Cause>**

- (1) The connection with PLC connected with each project is disconnected or NAK occurs.

**<Solution>**

- (1) When the communication is executed at first, Check the cable connected with PLC is OK or not.
- (2) If object where the offset is set is not shown, check whether address range is exceeded or not.
- (3) In case that communication is not OK, when communication is abnormal, the following message shows up in the XGT Panel.

Object type	Phenomenon
Bit Switch	The switch is expressed but it doesn't work.
Word Switch	The switch is expressed but it doesn't work.
Change Screen Switch	The switch is expressed but it doesn't work.
Special Switch	The switch is expressed but it doesn't work.
Multi Switch	The switch is expressed but it doesn't work.
Bit Lamp	Image is not shown.
Word Lamp	Image is not shown.
N-State Lamp	Image is not shown.
Clock	Present time is shown.
Bit Message	Message is not shown. When designating the background image, image is shown as it is.
Word Message	Message is not shown. When designating the background image, image is shown as it is.
Numeric Display	The value is not shown. When designating the background image, image is shown as it is.
Numeric input	The value is not shown. When designating the background image, image is shown as it is.
Text Display	Character string is not shown. When designating the background image, image is shown as it is.
Text Input	Character string is not shown. When designating the background image, image is shown as it is.
Bit Window	The window screen set in the object is not shown. But if communication is set with other object in the same window screen, it can be shown by that object.
Word Window	The window screen set in the object is not shown. But if communication is set with other object in the same window screen, it can be shown by that object.
Bit Part	The part screen set in the object is not shown. But if communication is set with other object in the same part screen, it can be shown by that object.

## Appendix 1. Troubleshooting

Object type	Phenomenon
Word Part	The part screen set in the object is not shown. But if communication is set with other object in the same part screen, it can be shown by that object.
Animation	Animation is not shown.
Bar Graph	Graph is not shown. When designating the background image, image is shown as it is.
Pie Graph	Graph is not shown. When designating the background image, image is shown as it is.
Meter Graph	Graph is not shown. When designating the background image, image is shown as it is.
Closed Graph	Graph is not shown. When designating the background image, image is shown as it is.
Trend Graph	X, Y axis is shown normally but trend axis is not normally shown. When designating the background image, image is shown as it is.
History Alarm Viewer	Change doesn't occur. When communication is abnormal, alarm occurs because it can't know the status of alarm target device. But previous alarm data shows up as it is.
Data list	Value is not shown. Lattice of viewing data list of object is shown as it is.
Logging Viewer	Change doesn't occur. When communication is normal, the recorded log data is shown normally. But, log data is shown as # when communication is abnormal.
Navigator	Change doesn't occur. Because it shows the group of alarm already developed, though communication is abnormal, if it has alarm data already developed, it shows the name of group where each alarm is included.

<b>Question</b>	The number indication object value is shown as # or ~
<b>Phenomenon</b>	The number indication object value is shown as # or ~. (Same phenomenon occurs at the number input device, viewing data list, and viewing logging)

### <Cause>

- (1) This happens when digit is not correct or type is not BCD.

### <Solution>

- (1) When the number to be expressed exceeds the number set in the object, # is expressed. In case of this, set the digit largely and after download again, execute program again.
- (2) When the numeric display object is expressed as BCD type, the data whose type is not BCD is expressed as ~. In case of this, adjust device value as BCD type.
- (3) This phenomenon occurs at the data list object, numeric input, numeric display device, and logging viewer.

<b>Question</b>	After switching the screen, the previous screen remains for a few minute
<b>Phenomenon</b>	After switching the screen, when there is no background or image in the part or number indication device, the previous screen remains for a few minute because of change of part

**< Cause >**

(1) After switching the screen, when connection is set up multiply or communication time-out occurs, the screen of previous part remains in some object.

**<Solution>**

(1) It is normal status. In case that multiple connection or communication is not good, when switching the screen, the remains of previous screen can occur during the time-out hour.

<b>Question</b>	The folded object doesn't sequentially show up
<b>Phenomenon</b>	The number under the data list shows up above data list.

**< Cause >**

(1) The device value is expressed at the top of object screen.

**<Solution>**

(1) It is normal status. The folded window or part object is not included in screen, regardless of sequence of drawing, the object changed recently is expressed at top of screen. So if possible, do not fold the object in screen.

<b>Question</b>	The object always shows up above the figure
<b>Phenomenon</b>	I downloaded the figure above the object in XP-Builder, but the object always shows up above the figure.

**< Cause >**

(1) In XGT Panel, The object always shows up above the figure.

**<Solution>**

(1) It is normal status. The object always shows up above figure in the XGT Panel.

### 5. Communication Problems

<b>Question</b>	It seems that communication does not work
<b>Phenomenon</b>	On the screen where the object is not many, communication works but when you move the screen where the object is many, timeout occurs.

**< Cause >**

- (1) In the device setting, the communication time-out is set to be too short.

**<Solution>**

- (1) It occurs because timeout is set much smaller than sum of request time of communication data and response time from PLC. In the device setting at the XP-Builder, after setting communication time out to be big, download program and execute again.

<b>Question</b>	It seems that communication doesn't work.
<b>Phenomenon</b>	Communication doesn't work.

**< Cause >**

- (1) Communication setting or cable may be not normal.

**<Solution>**

- (1) In case of RS-232C, check whether connection setting is normal or not in XP-Builder.
- (2) In case of RS-422/485, check whether station and communication connection setting is normal or not.
- (3) If 1), 2) is normal, do diagnosis about PLC-RS232C, PLC-RS485/422 at the Serial diagnosis screen of device menu. Refer to the [Device manual ch.5.6 Serial Communication Diagnosis]
- (4) If 3) is normal, check whether connection cable has error or not.
- (5) In case of Ethernet, check the port and IP setting about relative PLC.
- (6) In case of Ethernet, make sure that the IP and port settings for the other PLC are correct.

<b>Question</b>	It seems that communication doesn't work.
<b>Phenomenon</b>	Ethernet communication is connected slowly after monitoring starts.

**< Cause >**

- (1) Subnet of Ethernet port is the same.

**<Solution>**

- (1) If the subnets of the two Ethernet ports are the same, the initial connection may be delayed due to the seek time.
- (2) If possible, remove the Ethernet port's subnet.



### Caution

- ▶ Before trial operation of the product, be sure to check if a normal communication is available between XGT Panel and the subject device of control

## 6. USB Removal of Memory Card

<b>Question</b>	When removing the USB memory equipment, device is stopped for some times.
<b>Phenomenon</b>	This happens when doing data backup including logging, recipe.

**< Cause >**

- (1) This happens because memory card is removed when doing data backup.

**<Solution>**

- (1) If possible, when monitoring XGT Panel, do not remove the memory card and after going out to the waiting screen, execute the removing.
- (2) Inescapably you have to remove it during the operation, remove when backup does not occur. If the above phenomenon occurs, it works normally after about 10 seconds.
- (3) In case of USB memory, please remove it when the LED of USB external memory is not flickering.

<b>Question</b>	After the repeated attachment/detachment of the USB storage device, it is not recognized
<b>Phenomenon</b>	It can happen when the attachment/detachment of the USB device is repeated for a short period of time.

**<Cause>**

- (1) When the USB device is recognized or removed, it takes a certain period of time(maximum a few seconds) to recognize it. When the storage device is quickly installed/removed, however, it cannot be normally recognized.

**<Solution>**

- (1) It is recognized again after waiting for about a minute. Install it again after waiting for more than a minute.
- (2) When removing/reinstalling the USB device, reinstall it after waiting for around 2-3 seconds.



### Caution

- ▶ If you force to remove the data during the storage of data in the external memory, file may not be stored in a normal condition or external memory may suffer from damage.

## 7. External memory recognition

<b>Question</b>	USB, SD Card not recognized.
<b>Phenomenon</b>	The USB or SD card is inserted but the unit does not recognize it.

**<Cause>**

- (1) It appears when the USB memory or SD card is partitioned.

**<Solution>**

- (1) Please format USB memory or SD card as one partition.



### Caution

- ▶ If you forcefully remove the data from the external memory while it is being saved, the file may not be saved properly or the external memory may be damaged.

## 8. Touch recognition

<b>Question</b>	It recognizes that you have touched a place you do not want.
<b>Phenomenon</b>	The place where I did not touch was touched.

**<Caution>**

- (1) Check the surface of the touch panel for foreign matter such as water or oil.
- (2) Check if the power or communication cable is passing on the surface of the touch panel.

**<Solution>**

- (1) Clean the surface of the touch panel using a dry cloth or a towel
- (2) When cleaning the surface of the touch panel, be sure to turn off the power to prevent malfunction
- (3) Be careful not to let cables run near the touch panel



### Caution

- ▶ The electrostatic touch panel may cause malfunction if liquids such as water or oil get on the surface.
- ▶ If you need to clean the unit, be sure to turn off the power before cleaning.



**9. Error Message during Execution of Programs**

In case that problems occur during execution of XGT Panel including the start of device, diagnosis of device and environment setting, project download, monitoring of control device, and error messages occur as type of box. At this time the message indicates the code made by 4 digit number. The front 2 number indicate code of object and work, the rear 2 number is message number. In case that the present error message is indicated as [0101], an error message occurs when doing diagnosis about the status of NVRAM. When an error message occurs, refer to the row's number and sequence and find the category of reason and measure.

Object	Error code		Occurrence location	Error message	Reason and measure
	Type	Address			
Device diagnosis	0x01	0x01	XGT Panel	NVRAM Data Access ... FAILED!	Failed to check whether backup memory is normal or not. If this symptom is repeated, contact the near Customer Service Center.
		0x02	XGT Panel	BATTERY STATUS ... NOT GOOD!	Backup data is not valid. If this symptom is repeated when turning power off and on, remove XGT Panel's power and exchange the battery.
		0x03	XGT Panel	Write Operation FAILURE!	The built-in Flash disk has an error. Contact the near Customer Service Center.
		0x04	XGT Panel	Read Disk Information Error!	The built-in Flash disk has an error. Contact the near Customer Service Center.
		0x05	XGT Panel	Write Operation FAILURE!	Check that CF card is empty, and equip CF card and test again. If same symptom is repeated, CF card or CF card slot of XGT Panel may have a problem.
		0x06	XGT Panel	Read Disk Information Error!	Check that CF card is empty, and equip CF card and test again. If same symptom is repeated, CF card or CF card slot of XGT Panel may have a problem.
Device setting	0x02	0x01	XGT Panel	Invalid timeout value.	You inputted the wrong time which is not within backlight setting time range. Input the effective time.
		0x02	XGT Panel	Not found XGT Panel configuration file.	There is no setting information data of XGT Panel. If this symptom is repeated when turning power off and on, contact the near Customer Service Center.
		0x03	XGT Panel	Please enter an integer between 0 and 255.	When setting IP, the values within 0~255 are effective. Input the value within the above range.

Object	Error code		Occurrence location	Error message	Reason and measure
	Type	Address			
Viewing device information	0x03	0x01	XGT Panel	No project in XGT Panel.	Now, there is no downloaded project so you can't see connection information. Download the project from XP-Builder.
XGT Panel Update	0x04	0x01	XGT Panel	Failed to Start engine. Please update engine again.	Because of update error or Flash disk error, program can't be executed. If you can update, redo the above procedure. If you can't, contact the near Customer Service Center.
Switch	h05	h01	XGT Panel	Invalid password.	There is password in the each object. When editing the project downloaded in the present device, input the designated password at the project property information.
Number indication device/ Number input device	0x06	h01	XGT Panel	Can't write Data.	Because of communication error, the value can't be inputted. Check the communication status and input again.
		h02	XGT Panel	No input Data.	You tried to input with no value. Input the value
		0x03	XGT Panel	Exceeded the max length.	You exceed the maximum length to input.
		0x04	XGT Panel	Exceeded the minimum Value.	You exceed the maximum value to input.
		0x05	XGT Panel	Exceeded the maximum Value.	You exceed the minimum value to input.
		0x06	XGT Panel	Invalid at Input Case.	When you input the value, input can't be done because of wrong input. Check the input condition of each object in the Builder and input again.
Lamp	0x07			None	
Character indication device/ Character input device	0x08			None	
Message	0x09			None	
Clock	0x0A			None	
Animation	0x0B			None	
Graph	0x0C			None	
Window	0x0D			None	
Part	0x0E			None	
History alarm	0x0F			None	
Flow alarm	0x20			None	

## Appendix 1. Troubleshooting

Object	Error code		Occurrence location	Error message	Reason and measure
	Type	Address			
System alarm	0x21			None	
Scheduler related	0x22			None	
Recipe related	0x23			None	
Logging related	0x24			None	
Data list	0x25			None	
Project download	0x26	0x00	XGT Panel	Abnormal send-payload. Please download project again.	Communication status is abnormal. Check the connection of communication cable.
		0x01	XP Builder	There's not Password File.	This message shows up when making it newly because there is no password setting file in the device. When making it newly, it is initialized with no password.
		0x02	XP Builder	Failed to Create Password File.	It make new password setting file when there is no password setting file. But downloading is stopped when it fails to make this file because of device error. If this problem is repeated, Contact the near Customer Service Center.
		0x03	XP Builder	Invalid Backup Media.	Communication status is abnormal. Route information is not correct to save project data. If this problem is repeated, Contact the near Customer Service Center.
		0x04	XP Builder	Failed to Create version File.	In case that the version information file doesn't exist in the device, that file is made newly. In case that the device has error and fails to make that file, download is stopped. If this problem is repeated, Contact the near Customer Service Center.
		0x05	XP Builder	File Size Error.	There is version information file. In case that because of error of device, it fails to read version information, because the device doesn't know version, download is stopped. If this problem is repeated, Contact the near Customer Service Center.

Object	Error code		Occurrence location	Error message	Reason and measure
	Type	Address			
		0x06	XP Builder	Failed to get Project ID.	In case of not reading file where project property is included, download is stopped. If this problem is repeated, Contact the near Customer Service Center.
		0x07	XP Builder	Failed to read history alarm data.	In case of not reading information about alarm history because of error of NVRAM, download is stopped. If this problem is repeated, Contact the near Customer Service Center.
		0x08	XP Builder	Failed to read CF Card information.	Project is set to store data at CF card equipped at device. By the way, now it can't read information about CF card. Check the installation status of CF card and if it is normal, check the CF card. If this problem is repeated, contact Customer Service Center.
Project download	0x26	0x09	XP Builder	Failed to read USB information.	Project is set to store data at USB storage device equipped at device. By the way, now it can't read information about USB storage device. Check the installation status of USB storage device and if it is normal, check USB storage device. If this problem is repeated, contact Customer Service Center.
		0x0A	XP Builder	Failed to read Flash memory information.	In case that it can't know information about memory status, download is stopped. If this problem is repeated, contact Customer Service Center.
		0x0B	XP Builder	Failed to clear Temp Directory.	In case that because of error of Flash Disk, it can't delete the directory made temporarily for download because of error of Flash Disk, download is stopped. If this problem is repeated, contact Customer Service Center.
		0x0C	XGT Panel	Failed to delete Font File. Please reboot XGT Panel.	In case that it fail to delete the font file of previous project because of error of XGT Panel, download is stopped. If this problem is repeated, contact Customer Service Center.

## Appendix 1. Troubleshooting

Object	Error code		Occurrence location	Error message	Reason and measure
	Type	Address			
		0x0D	XGT Panel	Failed to delete Image File. Please reboot XGT Panel.	In case that it fail to delete the image file of previous project because of error of XGT Panel, download is stopped. If this problem is repeated, contact Customer Service Center.
		0x0E	XGT Panel	Failed to delete Sound File. Please reboot XGT Panel.	In case that it fail to delete the sound file of previous project because of error of XGT Panel, download is stopped. If this problem is repeated, contact Customer Service Center.
		0x0F	XGT Panel	There's no downloaded project. It needs to download whole project	It can't download part or fixed part in case there is no downloaded project. In case of this, download again. If this problem is repeated, contact Customer Service Center.
		0x10	XP Builder	Backup path is invalid. Please check the path that project is downloaded.	When user change the storage location of project data including image and font, if there is not respective routine, it make newly. By the way, download is stopped in case it fails to make newly. When it is designated as CF card, it can occur in case CF card is not installed. If this problem is repeated and not referred in the above, contact Customer Service Center.
		0x11	XGT Panel	Failed to delete previous project archive. Please reboot XGT Panel.	The project backup file downloaded already can be deleted because of error of XGT Panel. Reboot XGT Panel. If this problem is repeated, contact Customer Service Center.
Project download	0x26	0x12	XGT Panel	Failed to delete past project data files. Please download project again.	When downloading, the log data area in the NV-RAM is initialized in case of selecting previous project's the monitor data deletion option. By the way, in case of failing this, downloading is stopped. If this problem is repeated, contact Customer Service Center.
		0x15	XGT Panel	Failed to initialize LOGGING area in NV RAM. Please download project again.	When downloading, the log data area in the NV-RAM is initialized in case of selecting previous project's the monitor data deletion option. By the way, in case of failing this, downloading is stopped. If this problem is repeated, contact Customer Service Center.

Object	Error code		Occurrence location	Error message	Reason and measure
	Type	Address			
		0x16	XGT Panel	Failed to initialize RECIPE area in NV RAM. Please download project again.	When downloading, the alarm history in the NV-RAM is initialized in case of selecting the previous project's monitor data deletion option. By the way, in case of failing this, downloading is stopped. If this problem is repeated, contact Customer Service Center.
		0x17	XGT Panel	Failed to initialize ALARM area in NV RAM. Please download project again.	The downloaded font file is moved into original storage location but when this fails, downloading is stopped. If this symptom is repeated, contact Customer Service Center.
		0x18	XGT Panel	Failed to install font files. Please download project again.	The project data is divided into several files according to the contents but when this fails, downloading is stopped. If this symptom is repeated, contact Customer Service Center.
		0x19	XGT Panel	Failed to unmarshall download file. Please download project again.	The data divided according to the contents is moved to the original storage location but when this fails, downloading is stopped. If this symptom is repeated, contact Customer Service Center.
		0x1A	XGT Panel	Failed to install new project data files. Please download project again.	The downloaded project is not installed normally because of error of the Flash Disk. Download the project again. If this symptom is repeated, contact Customer Service Center.
		0x1B	XGT Panel	Failed to merge data files. Please download project again.	The downloaded project zip file is moved to the original storage location but when it fails, downloading is stopped. If this symptom is repeated, contact Customer Service Center.
		0x1C	XGT Panel	Failed to save new project archive. Please download project again.	There is a program to reboot engine program after downloading in the device but when it fails, this message shows up. But because the downloading is completed if you reboot engine directly, it works normally. The program name to reboot is startup.exe and it can be installed by engine upgrade function.

## Appendix 1. Troubleshooting

Object	Error code		Occurrence location	Error message	Reason and measure
	Type	Address			
Project download	0x26	0x1D	XGT Panel	Failed to XGP Panel startup program. Please update XGT Panel Software.	It can't find software to reboot XGT Panel. Update the XGT Panel.
		0x1E	XGT Panel	Project data is not downloaded. Please download project again.	The project data was not downloaded normally because of communication error. Check the connection status of communication cable and If this symptom is repeated, contact Customer Service Center.
		0x1F	XGT Panel/ XP-Builder	Failed to read Version information file. Please download project again.	There is version information file but when it can't read file normally because of the device error, downloading is stopped because it doesn't know version. If this symptom is repeated, contact Custom Service Center
Project download from USB storage device	0x27	0x51	XGT Panel	Cannot find project data in USB Storage	There is no USB or device status of USB is not good or project is not saved properly.
		0x52	XGT Panel	Project information file is not in USB Storage.	The project is not saved normally in the USB. Check whether there is XP_Project folder and [project name].inf in the USB or not.
		0x53	XGT Panel	Failed to read project information file.	It can't read project information file because the project is not saved in the USB normally. Save the project again from XP-Builder to the USB.
		0x54	XGT Panel	Device type is not matched.	The connected device type is not same as the device type set in the project in the USB. In case of this, project can't be downloaded into the device. Edit the project again or download according to the connected device.
		0x55	XGT Panel	Cannot read user password.	Information about the password can't be red because of the device error. If this symptom is repeated, contact Customer Service Center.
		0x56	XGT Panel	Password is not matched.	When saving the project, the password inputted by user is not same as present connection password. Input correct password and save the project.

Object	Error code		Occurrence location	Error message	Reason and measure
	Type	Address			
Project download from USB storage device	0x27	0x57	XGT Panel	Cannot read XGT Panel software version.	There is version information file but when it can't read file normally because of the device error, downloading is stopped because it doesn't know version. If this symptom is repeated, contact Customer Service Center.
		0x58	XGT Panel	XGT Panel software is old version. Please update XGT Panel.	The version of XP-Builder where project is saved is not compatible with present XGT Panel. Update the XGT Panel.
		0x58	XGT Panel	XP-Builder is old version. Please update XP-Builder.	The version of XP-Builder where project is saved is not compatible with present XGT Panel. Update the XGT Panel.
		0x59	XGT Panel	Cannot read download data format version.	There is storage structure version information file. But when it can't read this file because of the device error, downloading is stopped because it doesn't know the version. If this symptom is repeated, contact Customer Service Center.
		0x5A	XGT Panel	Download data format version is not matched. Please update XGT Panel.	Data storage type is not correct. Update XGT Panel.
		0x5A	XGT Panel	Download data format version is not matched. Please update XP-Builder.	Data storage type is not correct. Update the XP-Builder.
		0x5B	XGT Panel	Data file path is invalid.	There is no project data file at designated location. Check the connection status of USB and if there is no error, save the project to USB again.
		0x5C	XGT Panel	Download file name length is invalid.	The name of project data file is not saved correctly. Save the project at the USB again. If this symptom is repeated, contact Customer Service Center.
0x5D	XGT Panel	Cannot find download file.	The project data file can't be found. Save the project data file at the USB again. When this symptom is repeated, check the USB. If there is no error, contact Customer Service Center.		



## Appendix 1. Troubleshooting

Object	Error code		Occurrence location	Error message	Reason and measure
	Type	Address			
		0x5E	XGT Panel	Download file size is invalid.	The project data file is not saved correctly. Save the project data file at the USB again. When this symptom is repeated, check the USB. If there is no error, contact Customer Service Center.
Project download from USB storage device	0x27	0x5F	XGT Panel	Cannot find project backup file.	The project backup file which should be downloaded is not downloaded because of communication error. Download again.
		0x60	XGT Panel	Project backup file size is invalid.	The project backup file is saved incorrectly. Save the project at the USB storage equipment again. When this symptom is repeated, check the USB storage equipment and if the USB is normal, contact Customer Service Center.
		0x61	XGT Panel	Font file name length is invalid.	The font file's name is saved incorrectly. Save the project in the USB again. If this symptom is repeated, contact Customer Service Center.
		0x62	XGT Panel	Font file is not downloaded.	The font file which is needed for project is not saved in the USB storage equipment. Save the project in the USB. If this symptom is repeated, contact Customer Service Center.
		0x63	XGT Panel	Font file size is invalid.	The font file is not saved correctly. Save the project at the USB. Save the project at the USB. If this symptom is repeated, check the USB and if the USB is normal, contact Customer Service Center.
		0x64	XGT Panel	Cannot unmarshall download file.	The data can't be analyzed because the project data file is not saved correctly. Save the project at the USB again. If this symptom is repeated, check the USB and if the USB is normal, contact Customer Service Center.
		0x65	XGT Panel	Cannot delete previous project data.	The data of the project can't be deleted because of device error. If this symptom is repeated, check the USB and if the USB is normal, contact Customer Service Center.

Object	Error code		Occurrence location	Error message	Reason and measure
	Type	Address			
		0x66	XGT Panel	Cannot move new font files.	Downloaded font file is moved to the original storage location. But when it fails, the downloading is stopped. If this symptom is repeated, contact Customer Service Center.
		0x67	XGT Panel	Cannot move new project data files.	The project data classified according to the content is moved to the original storage location. But when it fails, the downloading is stopped. If this symptom is repeated, contact Customer Service Center.
		0x68	XGT Panel	Cannot move project backup file.	The downloaded project zip data is moved to the original storage location. But when it fails, the downloading is stopped. If this symptom is repeated, contact Customer Service Center.
XGT Panel booting	0x28	0x01	XGT Panel	Previous instance is not terminated.	XGT Panel software was already started. Reboot the device. If this symptom is repeated, contact Customer Service Center.
		0x02	XGT Panel	Start Server Fail. Restart XGT Panel	The XGT Panel software can't initialize the communication status normally. Check the communication status again. If this symptom is repeated when communication is normal, contact Customer Service Center.
		0x03	XGT Panel	Failed to Start Echo Server.	The XGT Panel software can't initialize the communication status normally. Check the communication status again. If this symptom is repeated when communication is normal, contact Customer Service Center.
		0x04	XGT Panel	Failed to accept connection.	The XGT Panel software can't initialize the communication with the XP-Builder normally. Check the communication status again. If this symptom is repeated when communication is normal, contact Customer Service Center.

## Appendix 1. Troubleshooting

Object	Error code		Occurrence location	Error message	Reason and measure
	Type	Address			
		0x05	XGT Panel	Failed to rename UpdateNew.exe	In the present XGT Panel the new updated XGT Panel software's name can not be changed. After rebooting the XGT Panel, update again. When rebooting, if you can't start engine, delete \\FlashDisk\LSISProduct\UpdateNew.exe in the XGT Panel. Then if you touch Update.exe and execute the XGT Panel, it can be update mode. Try update again. If this symptom is repeated, contact Customer Service Center
		0x06	XGT Panel	Failed to Delete Update.exe.	The new module is downloaded by the XGT Panel update but the previous module is not deleted. Reboot the device. If the XGT Panel software is not started normally, touch \\FlashDisk\LSISProduct\Update.exe in the XGT Panel. At this time, if XGT is set as update mode, update again. If this symptom is repeated, contact Customer Service Center.
Communication between other XP Builder-XGT Panel	0x29	0x30	XGT Panel	Failed to modify password file.	The device connection password can't be modified because of error of Flash Disk of XGT Panel. Reboot the device. If this symptom is repeated, contact Customer Service Center.
		0x31	XGT Panel	Password-related command transmission payload error	It failed to set and modify password because of communication status error. If this symptom is repeated, contact Customer Service Center.
		0x32	XGT Panel	There is no XGT Panel connection setting file.	The connection setting file of XGT Panel can't be found.
		0x33	XGT Panel	Modified content can't be saved in the XGT Panel connection setting file.	The modified information can't be saved at the connection setting file of XGT Panel. If this symptom is repeated, contact Customer Service Center.
		0x34	XGT Panel	Failed to set the time	The XGT Panel's time can't be set. If this symptom is repeated, contact Customer Service Center.

Object	Error code		Occurrence location	Error message	Reason and measure
	Type	Address			
XGT panel S/W update	0x30	0x21	XGT Panel/ XP-Builder	Failed to Create Initialized Module Version File.	Because the each module version information can't be read because of XGT Panel's error, it failed to initialize. If this symptom is repeated, contact Customer Service Center.
		0x22	XGT Panel/ XP-Builder	Module version file size is invalid.	The each module version information can't be read because of XGT Panel's error. If this symptom is repeated, contact Customer Service Center.
		0x23	XGT Panel/ XP-Builder	Can't Read module version file.	The each module version information can't be read because of XGT Panel's error. If this symptom is repeated, contact Customer Service Center.
		0x24	XP-Builder	There's no file to download.	The version information list to update is empty. Check the module folder newly designated at XP-Builder and if there is no error, download XGT Panel module and try update again. If this symptom is repeated, contact Customer Service Center.
		0x25	XP-Builder	Downloaded file is not Module to download.	The wrong file which is not in the new module list of XGT Panel is downloaded. Try update of XGT Panel again. If this symptom is repeated, contact Customer Service Center.
XGT panel S/W update	0x30	0x26	XGT Panel	Not enough space in flash memory.	The space to copy new module in XGT Panel is not enough. After deleting the unnecessary file or backing up the previous file to the movable storage equipment, try update again. If this symptom is repeated after deleting, contact Customer Service Center.
		0x27	XGT Panel	Failed to Copy module ~.dll	The new module is not installed because of XGT Panel's error. After rebooting the device, touch \\FlashDisk\LSISProduct\Update.exe and set the device as update mode. Then update again. If this symptom is repeated, contact Customer Service Center.

## Appendix 1. Troubleshooting

Object	Error code		Occurrence location	Error message	Reason and measure
	Type	Address			
		0x28	XGT Panel	Failed to Start Engine. Please update engine again.	To reboot the engine is not available because of wrong file which is developed by downloading wrong module or communication error. Touch \\FlashDisk\LSISProduct\Update.exe and set the device as update mode. Then update again. If this symptom is repeated, contact Customer Service Center.
		0x2A	XGT Panel	Failed to write Data to Module version File.	It is failed to record the version information during update of XGT Panel. If this symptom is repeated, contact Customer Service Center.
		0x2B	XGT Panel	There's no downloaded file.	To reboot the engine is not available because of wrong file which is developed by downloading wrong module or communication error. Touch \\FlashDisk\LSISProduct\Update.exe and set the device as update mode. Then update again. If this symptom is repeated, contact Customer Service Center.
		0x2C	XGT Panel	(improper communication command) Current state is not authorized.	To reboot the engine is not available because of wrong file which is developed by downloading wrong module or communication error. Touch \\FlashDisk\LSISProduct\Update.exe and set the device as update mode. Then update again. If this symptom is repeated, contact Customer Service Center.
XGT panel S/W update	0x30	0x2D	XGT Panel	(improper communication command) A module to download is not listed up yet.	To reboot the engine is not available because of wrong file which is developed by downloading wrong module or communication error. Touch \\FlashDisk\LSISProduct\Update.exe and set the device as update mode. Then update again. If this symptom is repeated, contact Customer Service Center.

Object	Error code		Occurrence location	Error message	Reason and measure
	Type	Address			
		0x2E	XGT Panel	Failed to Initialize Update program.	XGT can't be set as update mode because of XGT Panel error. After downloading new XGT Panel module through homepage, etc., copy UpdateNew.exe file among new module to the \\FlashDisk\LSISProduct\ directory of XGT Panel through the movable storage equipment. Then reboot the XGT Panel and go update mode and update again. If this symptom is repeated, contact Customer Service Center.

## Appendix 2 Dimensions (Unit: mm)

### 1. iXP2-08xxA/D

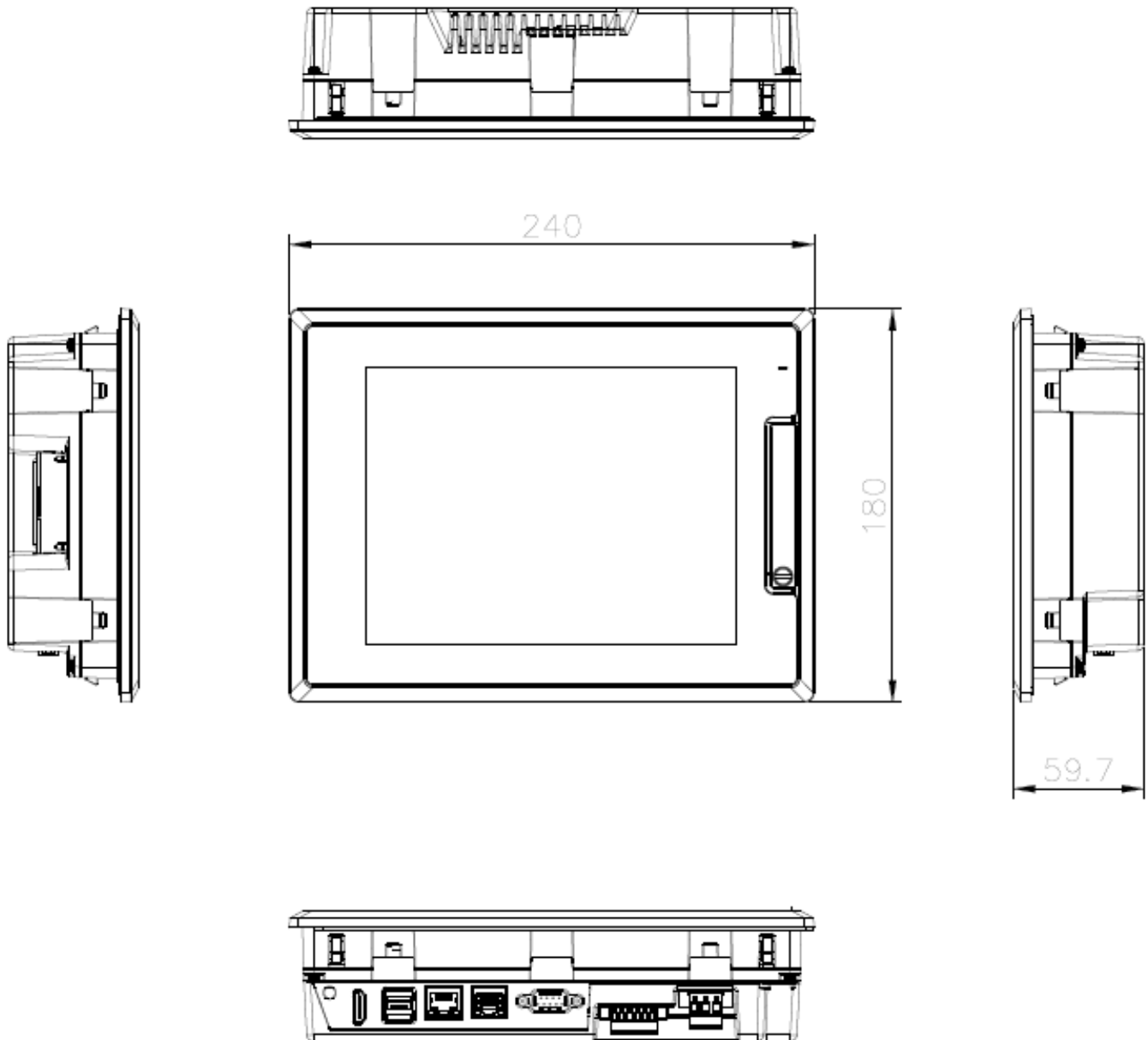

2. iXP2-10xxA/D

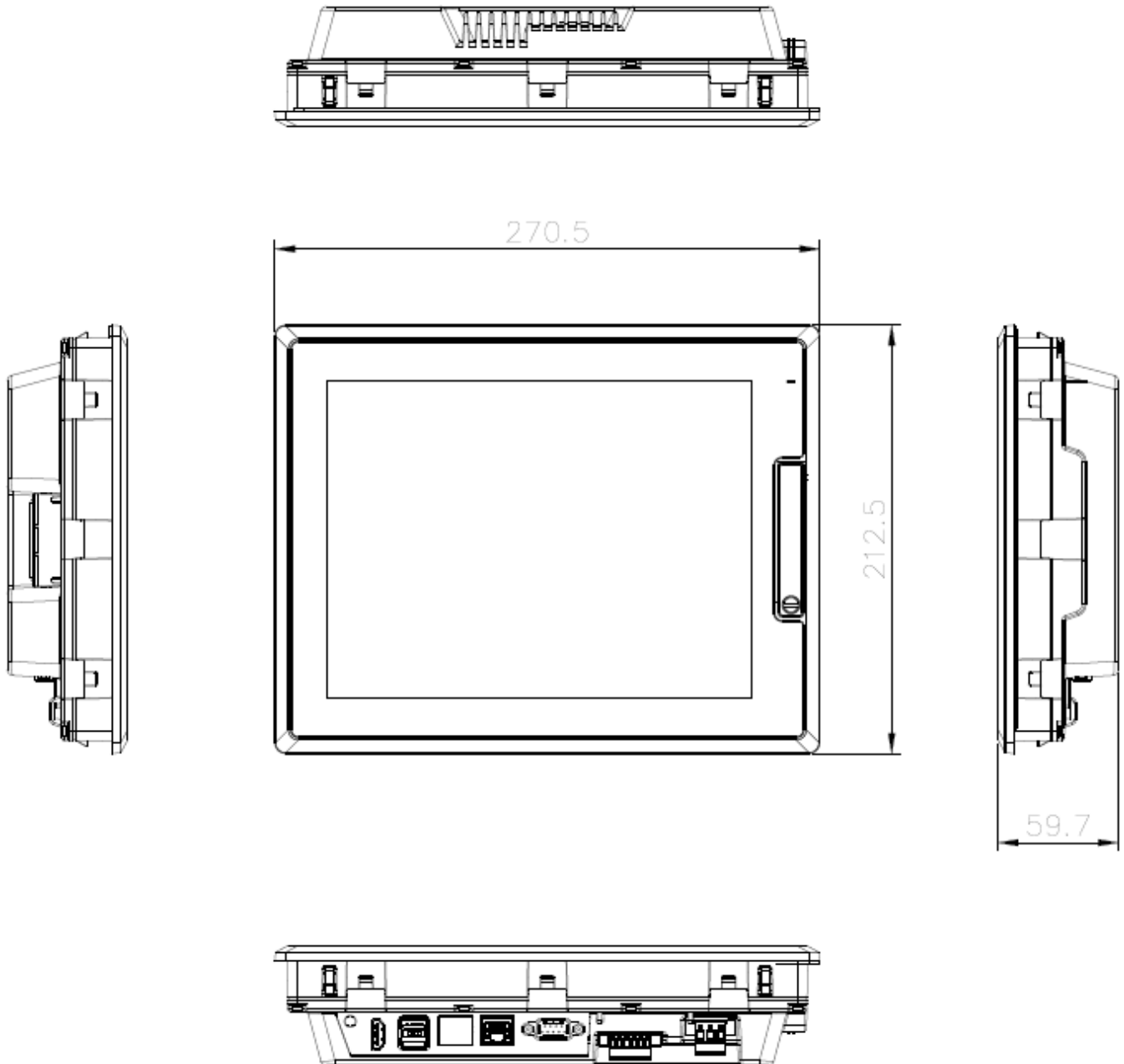



3. iXP2-12xxA/D

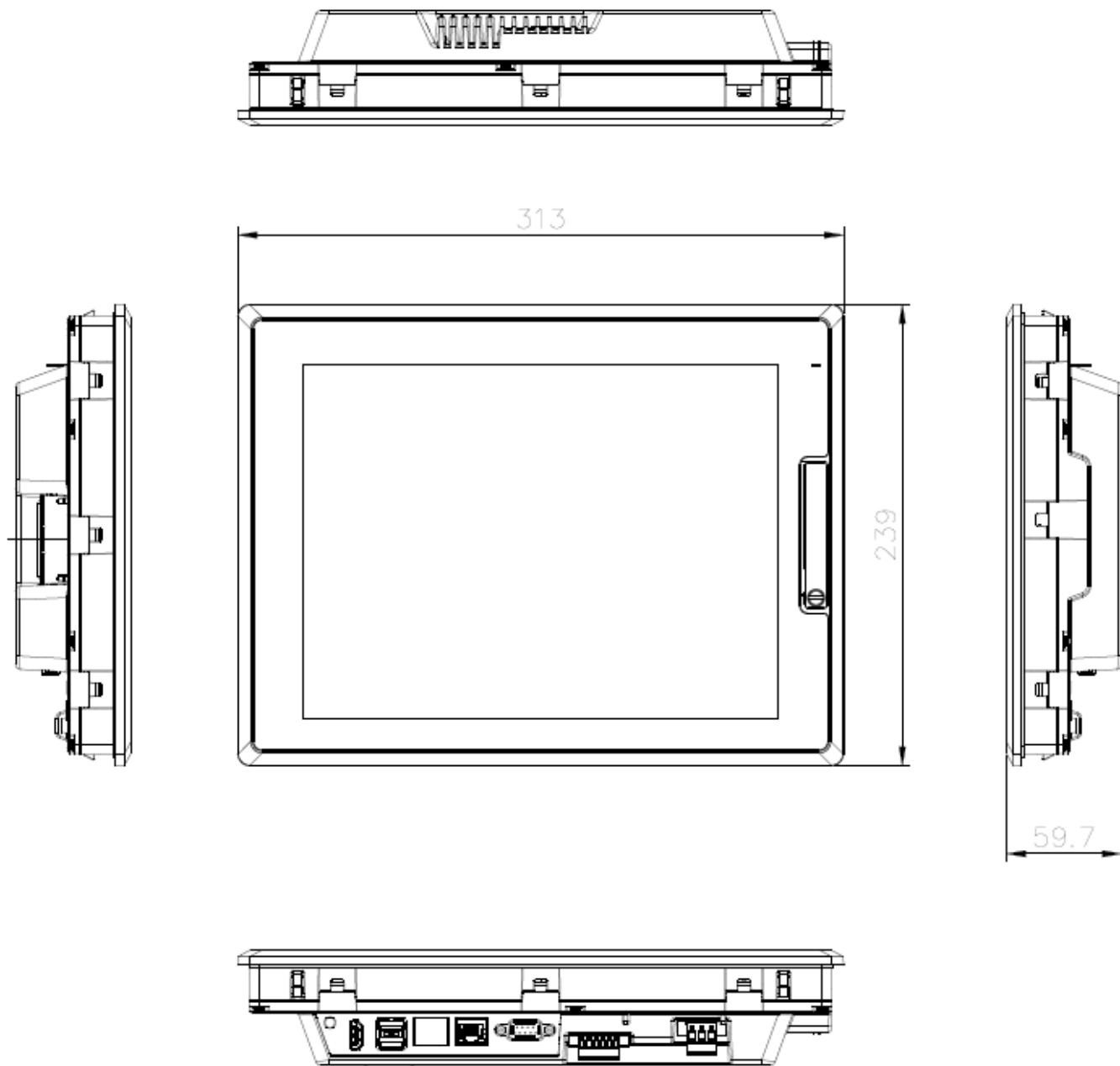

4. iXP2-15xxA/D

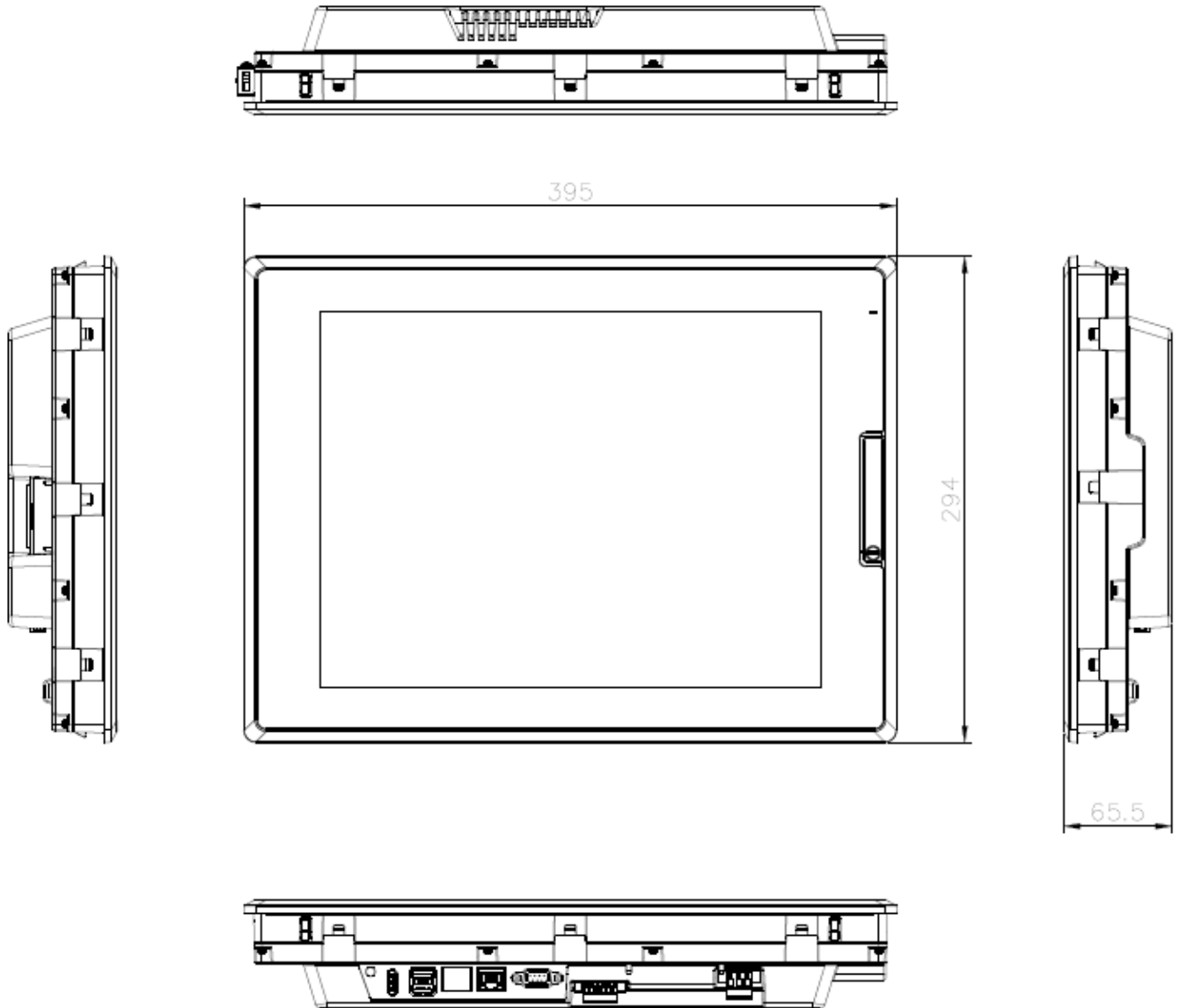

## Appendix 3 Warranty and Environmental Policy

### 1. Warranty contents

#### One. Warranty

The warranty period for your product is 18 months from the date of manufacture.

#### 2. Scope of warranty

Partial replacements or repairs are available for any faults that occur during the above warranty period.

However, please note that if it falls under the following, it will be excluded from the guarantee range.

- (1) In case of improper condition, environment, or handling other than those specified in the instruction manual
- (2) If the cause of the fault is something other than our own product
- (3) If the product has been modified or repaired outside of the designated spot designated by the Company or the Company.
- (4) If the product is not intended for its original use
- (5) When the product is shipped from the Company, due to unforeseen circumstances at the level of science or technology
- (6) If there is no responsibility for other genius, fire, etc.

3. The above warranty is only the guarantee of the HMI unit.

### 2. Environmental Policy

LS ELECTRIC is following the environmental policy as follows.

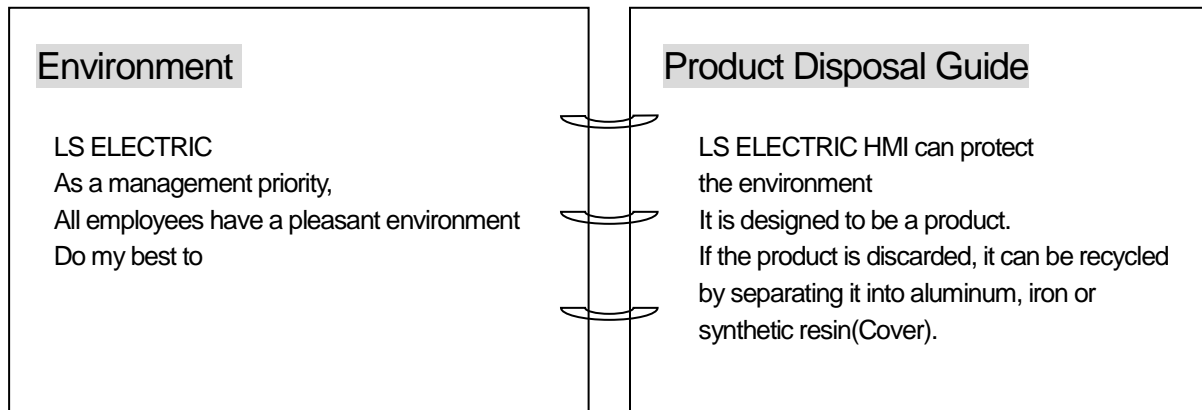



[www.lselectric.co.kr](http://www.lselectric.co.kr)

## LS ELECTRIC Co., Ltd.

### ■ Headquarter

LS-ro 127(Hogye-dong) Dongan-gu, Anyang-si, Gyeonggi-Do, 14119, Korea

### ■ Seoul Office

LS Yongsan Tower, 92, Hangang-daero, Yongsan-gu, Seoul, 04386, Korea  
Tel: 82-2-2034-4033, 4888, 4703 Fax: 82-2-2034-4588  
E-mail: automation@lselectric.co.kr

### ■ Factory

56, Samseong 4-gil, Mokcheon-eup, Dongnam-gu, Cheonan-si, Chungcheongnam-do, 31226, Korea

### ■ Overseas Subsidiaries

- **LS ELECTRIC Japan Co., Ltd. (Tokyo, Japan)**  
Tel: 81-3-6268-8241 E-Mail: jschuna@lselectric.biz
- **LS ELECTRIC (Dalian) Co., Ltd. (Dalian, China)**  
Tel: 86-411-8730-6495 E-Mail: jiheo@lselectric.com.cn
- **LS ELECTRIC (Wuxi) Co., Ltd. (Wuxi, China)**  
Tel: 86-510-6851-6666 E-Mail: sblee@lselectric.co.kr
- **LS ELECTRIC Shanghai Office (China)**  
Tel: 86-21-5237-9977 E-Mail: tsjun@lselectric.com.cn
- **LS ELECTRIC Vietnam Co., Ltd.**  
Tel: 84-93-631-4099 E-Mail: jhchoi4@lselectric.biz (Hanoi)  
Tel: 84-28-3823-7890 E-Mail: sjbaik@lselectric.biz (Hochiminh)
- **LS ELECTRIC Middle East FZE (Dubai, U.A.E.)**  
Tel: 971-4-886-5360 E-Mail: salesme@lselectric.biz
- **LS ELECTRIC Europe B.V. (Hoofddorf, Netherlands)**  
Tel: 31-20-654-1424 E-Mail: europartner@lselectric.biz
- **LS ELECTRIC America Inc. (Chicago, USA)**  
Tel: 1-800-891-2941 E-Mail: sales.us@lselectricamerica.com



Specifications in this instruction manual are subject to change without notice due to continuous products development and improvement.