

CE
Approved for Digital
Weigh Indicator

Digital Weighing Indicator SI 480E

Instruction Manual



2014. 06. 25

 **SEWHACNM**
주식회사 세화씨엔엠

CONTENTS

1. Before Installation	-----	3 Page
2. Introduction	-----	4 Page
3. Specification	-----	5 Page
3-1. Specification	-----	5 Page
3-2. Front Panel	-----	6 Page
3-3. Rear Panel	-----	8 Page
4. Installation	-----	9 Page
4-1. Dimension & Cutting Size	-----	9 Page
4-2. Installation Components	-----	9 Page
4-3. Load Cell Installation	-----	10 Page
5. Set up	-----	11 Page
5-1. Set Up mode	-----	11 Page
5-2. TEST Weight Calibration Mode	-----	14 Page
5-3. Simulating Calibration Mode	-----	18 Page
5-4. F-FUNCTION Setting	-----	22 Page
5-5. Test Mode	-----	34 Page
6. Interface	-----	37 Page
6-1. Serial Interface	-----	37 Page
6-2. Serial Print	-----	47 Page
7. Error & Treatment	-----	48 Page
7-1. Load Cell Error & Treatment	-----	48 Page
7-2. Calibration Error & Treatment	-----	49 Page
7-3. Indicator Error & Treatment	-----	50 Page
Warrantee Certificate	-----	51 Page

1. BEFORE INSTALLATION

Caution / Warning Marks



This mark warns the possibility to arrive death or serious injury in case of wrongly used.



This mark cautions the possibility to arrive serious human body injury or product lose in case of wrongly used.

Copy Rights

1. All Right and Authority for this Manual is belonged to SEWHA CNM CO., LTD.
2. Any kinds of copy or distribution without permission of SEWHA CNM CO., LTD. will be prohibited.
3. This manual may be changed as the version is upgraded, without previous notice.

Inquiries

If you have any kinds of inquiries for this model, please contact your local agent or Head Office.

Head Office : SEWHA CNM CO., LTD.

Website : <http://www.sewhacnm.co.kr>

Email : sales@sewhacnm.co.kr

2. INTRODUCTION

2-1. Introduction

Thank you for your choice of this SI480E Industrial Digital Weighing Indicator.

This SI480E model is high-performance weighing Indicator.

Please review and learn this instruction Manual and enjoy your process efficiency with "SI 480E" Weighing Indicator.

2-2. Cautions



1. Don't drop on the ground and avoid serious external damage on item.
2. Don't install under sunshine or heavy vibrated condition.
3. Don't install place where high voltage or heavy electric noise condition.
4. When you connect with other devices, please turn off the power of item.
5. Avoid from water damage.
6. For the improvement of function or performance, we can change item specification without previous notice or permission.
7. Item's performance will be up-dated continuously base on previous version's performance.
8. If the equipment is used in a manner not specified by the manufacturer, the protection provided by the equipment may be impaired.
9. If the operation environment is dusty, regular cleaning might be needed.

2-3. Features

1. SI 480E model is the standard 1/8 DIN SIZE and compact enough, so it is easy to install.
2. It has wide range of DC Input.
3. Front panel is covered with Polycarbonate film, strong against dust and water.
4. RS-422/485 serial port standard installed.

3. SPECIFICATION

3-1 Specification

Content		Specification	
Performance	External Resolution	1/20,000	
	Internal Resolution	1/2,097,152 (±1,048,576)	
	Input Sensitivity	Min. 0.1μV/V	
	Max Signal Input Voltage	3.0mV/V	
	Load cell Excitation	DC +5V	
	A/D Conversion Method	Sigma-Delta	
	Decimal Point	0, 0.0, 0.00, 0.000	
	Drift	10PPM/°C	10PPM/°C
		10PPM/°C	10PPM/°C
	Linearity	0.001% of Full Scale	
Analogue Sampling(sec)	60times / sec(MAX)		
Environment	Operating Temperature Range	-10°C ~ +40°C [14°F ~ 104°F]	
	Operation Humidity Range	40% ~ 85% RH, Non-condensing	
Function	Calibration Mode	Test Weight Calibration Mode Simulation Calibration Mode	
	Display	6 digit, 15mm(0.6inch) Red Color FND	
	Key Pad	5EA Standard Key	
	Additional Digital Input	2pcs addable	
Communication	Serial Interface(RS-422/485)	Data Transference, Command Mode Serial Print, MODBUS(RTU)	
Power	Input Power DC 24V Power Consumption MAX 8W		
Size	96mm(W) x 48mm(H) x 135mm(D) Including Connector Weight : 300g		

3-2. Front Panel



3-2-1 Front Panel (Display / Key Pad)





3-2-2. State Lamp

STEADY	When the weight is "STEADY", Lamp is ON.
ZERO	When the current weight is "ZERO", Lamp is ON.
TARE	"TARE" function is set, Lamp is ON.
HOLD	"HOLD" function is set, Lamp is ON.
TxD	When the Indicator transmits Serial communication data (Print data), Lamp is ON.
RxD	When the Indicator receives Serial communication data, Lamp is ON.



3-2-3. Key Operation

	<ol style="list-style-type: none"> 1. Normal Mode : Make Weight value as Zero. 2. Calibration Mode : Cancel the value or move to previous step. 3. F-Function setting : Cancel 4. Set point setting : Cancel
	<ol style="list-style-type: none"> 1. Normal Mode : Set the TARE Function (1st input : "TARE", 2nd input : "TARE Reset") (When "HOLD" or weight value is ZERO, then this key doesn't work.) 2. Calibration Mode : Move to left 3. F-Function setting : Move to left

	<ol style="list-style-type: none"> 1. To set the "HOLD" Function (1st input : "HOLD", 2nd input : "HOLD Reset") 2. Calibration Mode , F-Function setting : Move to right 3. Under "SETUP" Mode, Enter into the "Calibration" Mode. 4. Go into test mode 1 5. Under HOLD setting first digit as "H"
	<ol style="list-style-type: none"> 1. Normal Mode : Print out 2. Calibration Mode , F-Function setting : Increase set value 3. Go into test mode 2 4. Set up Mode : Enter Test Mode. 5. If F-102 set 0, 4, 5, 6 able to weight data to save
	<ol style="list-style-type: none"> 1. Normal Mode : Press this key 4times, within 2secs, enter to "SET-UP" mode. 2. Hidden Mode : on pressing this key by 4 second enter to "Hidden" mode. 2. Calibration Mode : Enter 3. F-Function setting : Save the value go to next step

● Setup Mode : It is a mode can SET UP the calibration, Function of SI480E .(refer to CH5. SET UP)

3-2-4. Hot key (with F key)

	<p>Continuous "TARE" setting (From the second TARE setting, use this key)</p>
	<p>If the Printer is installed, You can print out the "Grand-total data". (GRAND-total data can be checked though Print output).</p>

Tip

Max accumulated weighing count: 999,999times

Over 999,999times → return to "0" time

Max accumulated weight display: 999999999 (g, kg, ton)

Over 999,999,999 (g, kg, ton) → return to "0" (g, kg, ton)

3-3 Rear Panel

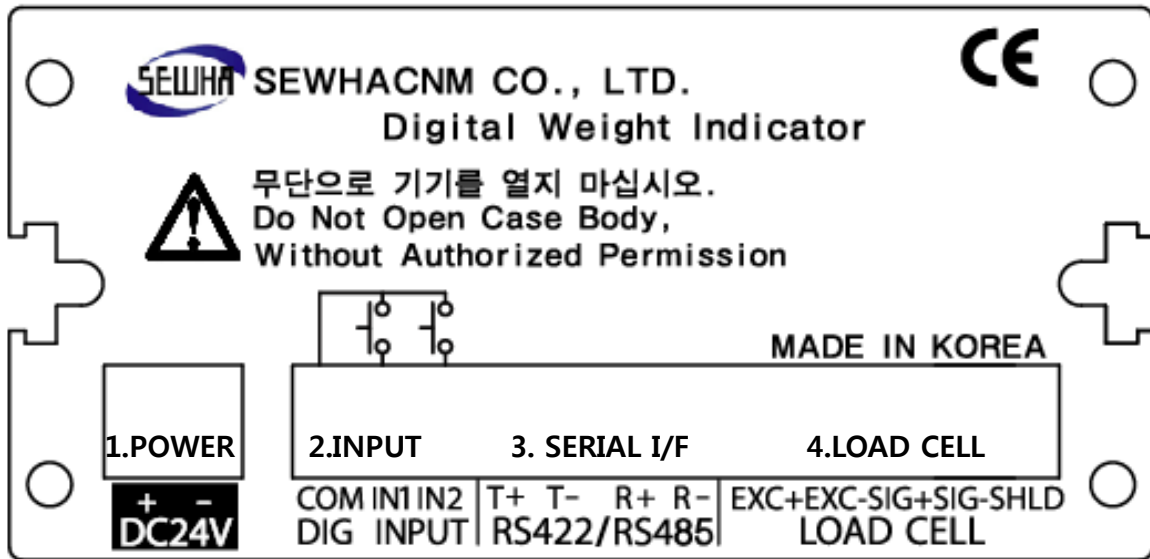

1. Power DC IN: 24V (Power: 24V 1A recommended)

2. External Input terminal: Bottom side 2 port

(Refer to F-233, 234 to select desired function of each input terminal)

3. Serial Interface terminal: Stand serial port is RS485

Communication Method	TX+ Terminal	TX- Terminal	RX+ Terminal	RX- Terminal
RS – 422(Standard)	TX+	TX-	RX+	RX-
RS – 485(Standard)	Not used	Not used	RTX +	RTX-
RS – 232(Oder spec)	GND	Not used	TX	RX

4. Load cell Input

EXC+	EXC-	SIG+	SIG-	SHIELD
------	------	------	------	--------



Please check the Comm. and other specification in the label, attached on the cover plate first, and make connection according to that information.

4. INSTALLATION

4-1. External Dimension & Cutting Size

External Dimension (unit: mm)

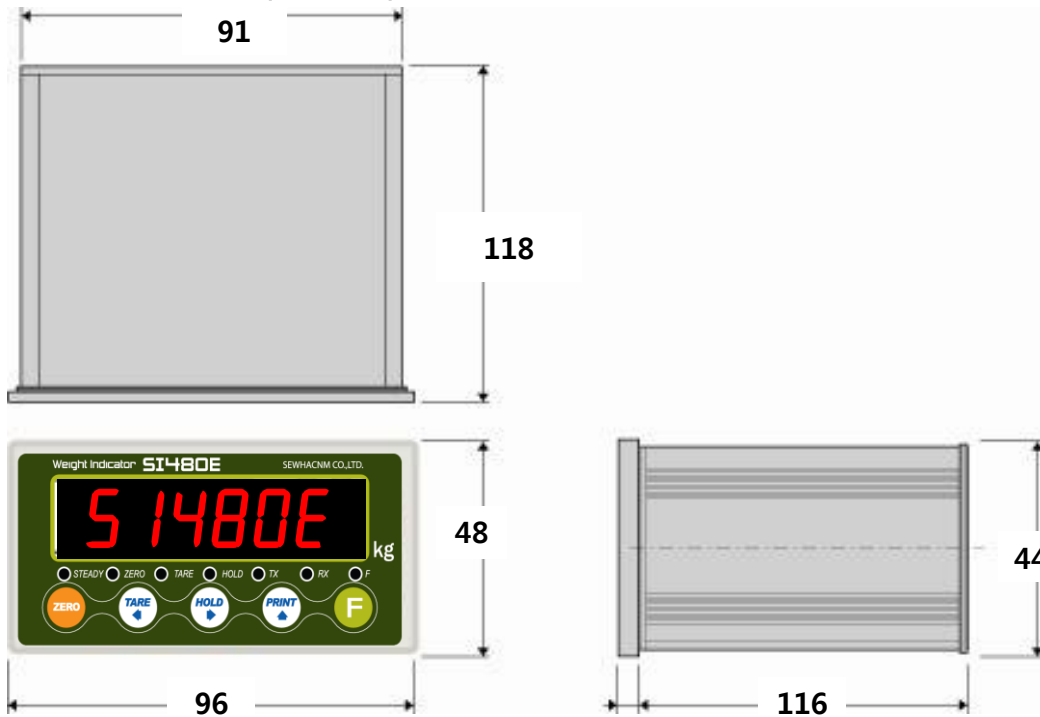

2

Cutting Size (unit : mm)

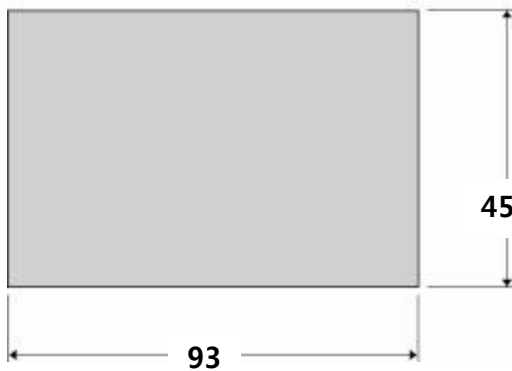

4-2. Installation Components



SI480E

Connector (3EA)
3P, 5P, 7P

Pin terminal(15EA)

User Manual

4-3 Load cell Installation

Load Cell Wire Connection (In case of SEWHACNM's Load cell)

It depends on the manufacturer of load cell, please check the specification.



-----Sewhacnm Co.,Ltd. Load cell & wire color----

※ Load cell wire color can be changed without prior notice.



Caution Under set up the Load cell, if EXC+ and EXC- have a short circuit, It may cause damage in the indicator.(specially analogue board)
If you connect other wires to Load cell terminal wrongly, it may cause damage in the analogue board.
Before connecting the load cell cable you have to power off and be sure to connect the cable to the terminal correctly.
Do not weld near the load cells , Indicators or other devices.

Load Cell Installation

1. You can connect Max 8pcs of same capacity Load cells at once. (350 Ω)
2. You have to make horizontal balance on the ground.
3. If you install more than 2pcs of load cells, use Summing box and adjust output signal difference as minimum. It can make wrong weighing process caused by each load cell's variation.
4. If there is some temperature difference around Load cell, it can cause wrong weight measurement.
5. Don't do Welding job or Arc discharge around installation place. But, there is no choice, please disconnect power cable and Load cell cable.
6. If you measure static electricity material, please make earth between down part and up part of Load cell.

5. SET-UP

5-1. Set up

This is the Menu which can set the all of the functions.

There may be some display differences between real and on the manual.

5-1-1. Start "SET UP" Mode (Password is not used)

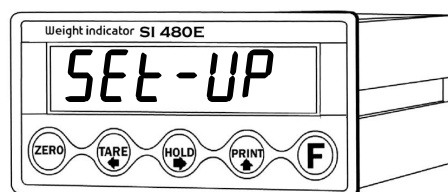
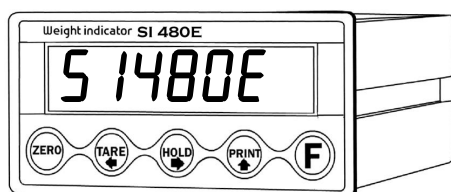

Press  key four times within 2sec

When "SET UP" is displayed, SETUP Mode is activated

5-1-2. Start "SET UP" Mode (Password Use – Refer Hidden Option HF07)

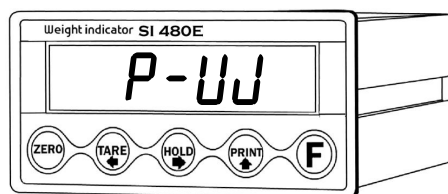
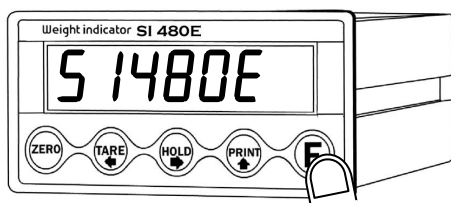

Press  key four times within 2sec

If "P-W" displays, input 4 characters password.

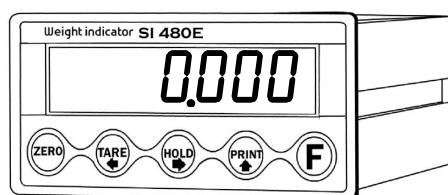
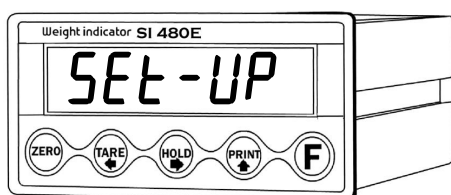























If Password is right, "SETUP" Mode starts.

If Password is wrong, it is back to weighing display.



If you set password by "HF07", "TEST" mode, you cannot start "SETUP" Mode without password. Please don't forget the pass word.

To Go Each Mode

Calibration	Weight Calibration	 key during 4 seconds → Pass word →  → 
	Simulation Calibration	 key during 4 seconds → Pass word →  → 
F-FUNCTION Mode		 key 4 times 
Test Mode1	Analog Value	 key 4 times →  → 
	Display	 key 4 times →  → 
	Key test	 key 4 times →  → 
Test Mode2	Serial I/F	 key 4 times →  → 
	Standard Serial I/F	 key 4 times →  → 

● Entering  means ESC/UPPER step, Entering  means SAVE/NEXT Step.

■ Adjusting “ZERO” Balance (Calibration)

Adjust weight balance between “Real weight” on the load cell) and “Displayed weight of Indicator”. When you replace LOAD CELL or Indicator, you have to Calibration process once again.

(When you start calibration mode, TARE, HOLD & PRINT will be reset.)



Before processing calibration, please warm up the indicator during 15 min to guarantee more preciseness.

Calibration Key



CANCLE/BACK

Move to left

Move to right

Increase set value

Save and Move
to next step

5-2 Test Weight Calibration Mode (Using test weight)

5-2-1. Start Test Weight Calibration Mode

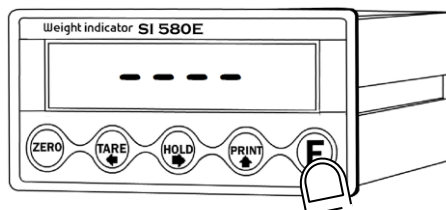
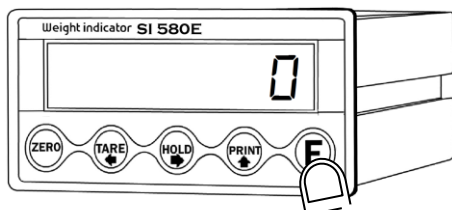

On pressing  key for 4 seconds

On the screen "----", input **PASSWORD**

press  key

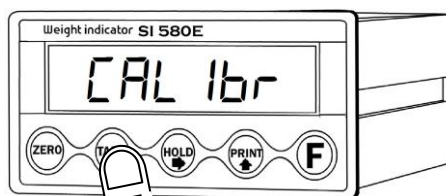
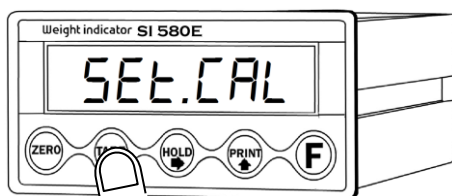

On the screen "SET.CAL" press  key

On the screen "CALIBR", press  key
Go into CALIBRATION MODE

5-2-2. Setting "Capacity of weighing Scale"

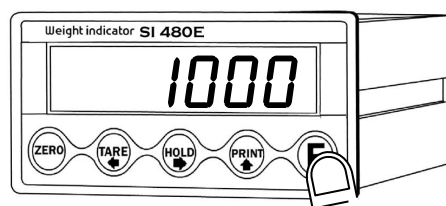
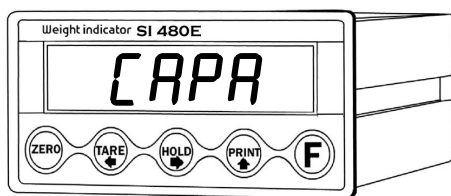

When "CAPA" is showed, input max capacity with keys & Press  key to save the data & move to next step.

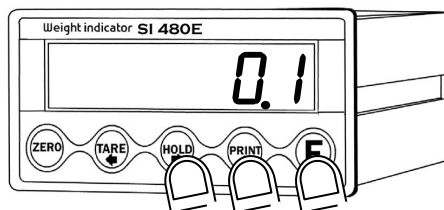
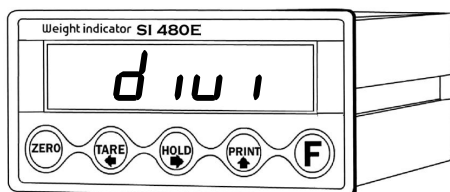

Tip If you want that set Max capacity is 1,000kg, then just input "1000".

5-2-3. "Decimal Point" and "Digit / Division" Value



After "DIVI" is displayed, set Decimal point with  key.

Whenever you press  key, the decimal point will be changed.

And set Division value with  key, finally press  key to save the data.

Tip

Max Decimal point will be 0.001, and digit can be selectable among 1, 2, 5, 10, 20, 50.

Digit and Decimal point must be fulfill the below condition.

(Division value /Max capacity value) can not over 1/20,000.

If the division is so small compare with max capacity,

Error message "Err 01" will be displayed and move back to

"CAPACITY" step again.

5-2-4. Measure the "DEAD" Weight of Weighing Scale.

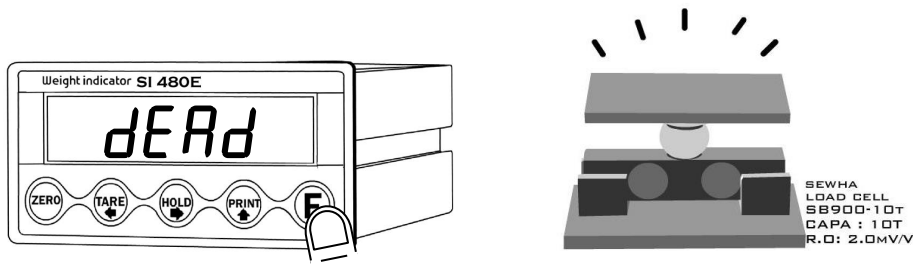

When "DEAD" is displayed, press  key, then indicator will calculate Dead weight of scale part automatically.

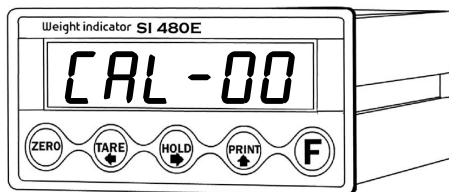

Indicator will search "DEAD weight" during 10~20 seconds to find the best condition.

※ To guarantee the preciseness, DEAD weight calculation (CAL00~CAL09) will be operated twice when resolution (Division value /Max capacity value) is less than 1/10,000.

Tip At this step, if there is some force or vibration on weighing scale, and unstable conditions will be continued, "Err-A" will be display, and "DEAD value" will not be calculated. Please remove all the force or vibration and process it again.

5-2-5. Input Test Weight value and Calculate SPAN value.

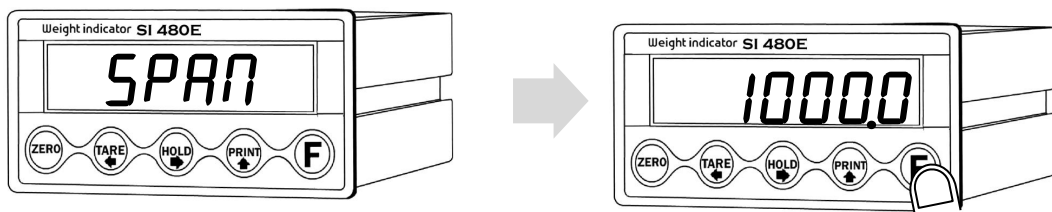

If "SPAN" is displayed, input "Test Weight" capacity and press  key.

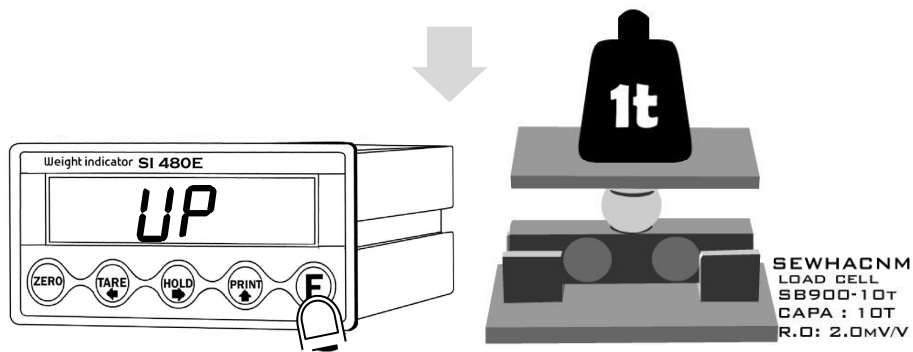

When "UP" is displayed, load your test weight on the scale (weigh bridge) and press **F** key.
 Ex) Load Cell CAPA : 20kg, division 0.001

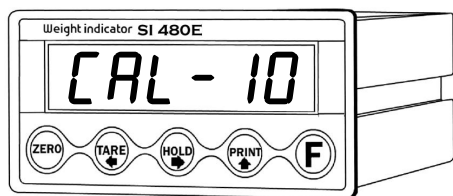

Calculate Span value during 10 ~20 second, automatically.

※ To guarantee the preciseness, SPAN calculation (CAL00~CAL09) will be operated twice when resolution (Division value /Max capacity value) is less than 1/10,000.

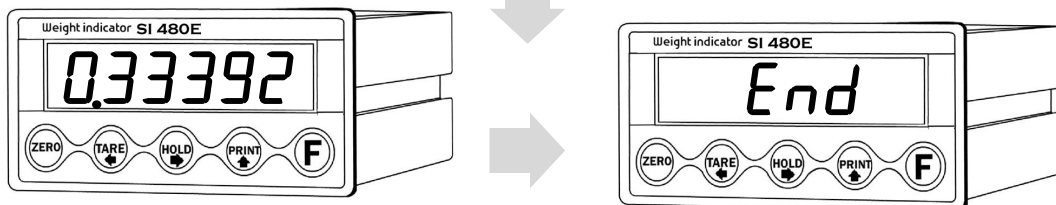

After calculation, span value will be displayed

on the display. Then press **F** key.

※This span value is not a weight value.

When "END" is displayed and calibration is completed.

5-3. Simulation Calibration Mode(without Test weight)

With this "Simulation Calibration Mode" you can make simple calibration without any "TEST weight"

This calibration mode uses "Load cells' max capacity" and "Max Output Rate(mV)", so the weight adjustment degree might be less than "Test weight Calibration".

The guaranteed resolution of this "Simulation Calibration" is 1/3,000.

5-3-1. Simulation Calibration Mode Start

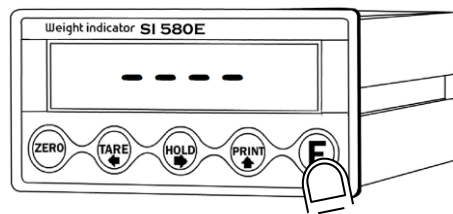
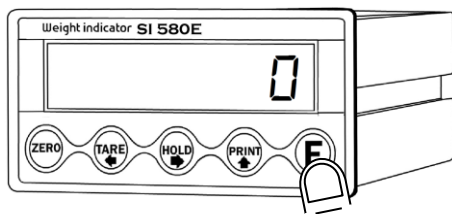

On pressing  key for 4 seconds

On the screen "----", input **PASSWORD**

press  key

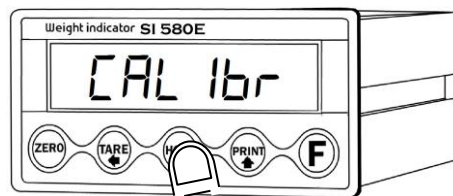
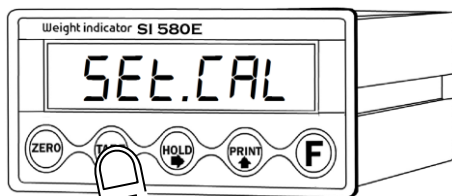

On the screen "SET.CAL" press  key

On the screen "CALIBR", press  key
Go into CALIBRATION MODE

5-3-2. Setting "Capacity of Load Cell"

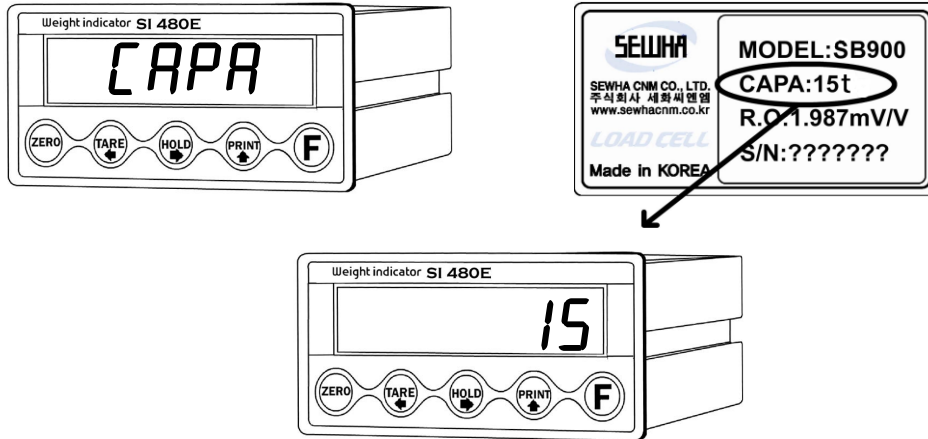



After "CAPA" is displayed, Check the max Capacity of your load cell.
(Refer the label on the load cell, or test report.)

Input the Max Capacity of Load cell. And press  key.

Tip In case of multiple pieces of load cells are installed, make sum of each load cell's capacity and make setting with max capacity.
Ex) If there are 4pcs of load cells, and each load cell's Max capacity is 1,000kg.
 Then, total Max Capacity will be 4,000kg (1,000 x 4) and you have to input 4,000.

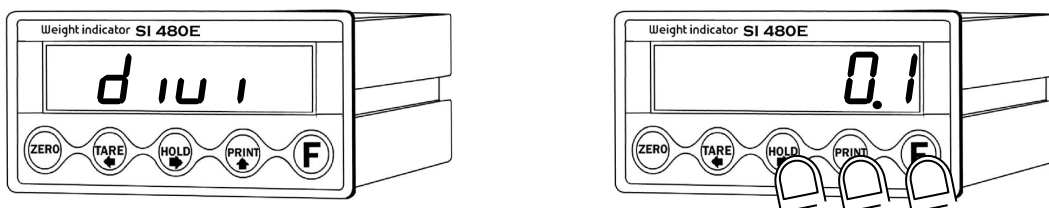
5-3-3. Setting "Digit / Division" value



After "DIVI" is displayed, select Decimal point with  key.

Whenever you press  key, decimal point will be changed.

And select Division optimal division with  key.

Finally press  key to save and move to next step.

5-3-4. Measure the "DEAD Weight" of Weighing Scale.

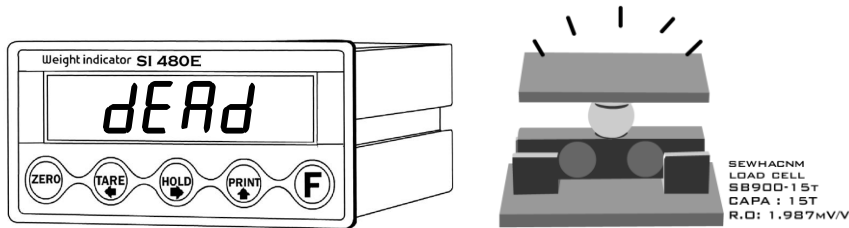

When "DEAD" is displayed, press **F** key with empty scale.
 The indicator starts to measure and find optimal "Dead weight value of Scale" automatically.

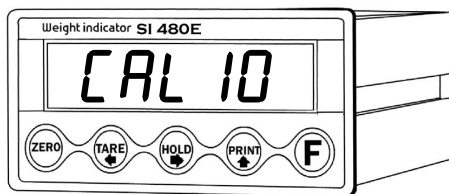

It takes 10 or 20 second to get the best situation.

※ To guarantee the preciseness, DEAD weight calculation (CAL00~CAL09) will be operated twice when resolution (Division value /Max capacity value) is less than 1/10,000.

5-3-5. Input Max Output (Rated Output Voltage / mV)

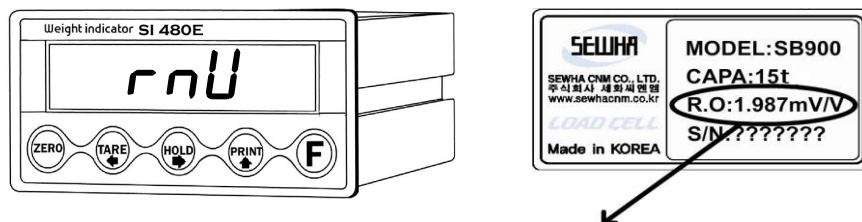

Input the output value load cell
 Following fixed decimal point.

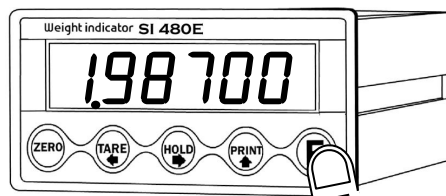

After "mV" is displayed, Check the Rated output value of Load cell.

(Refer to the load cell label, or Test Report). And Press **F** key to save and move to next step.

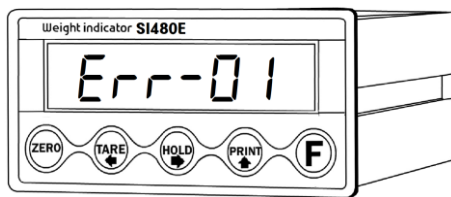

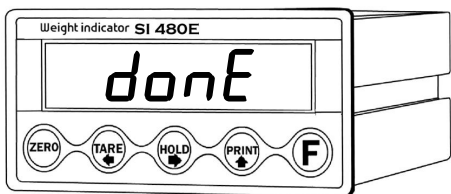

If input wrong value, there will display "Err-01", please go back to *Setting "Capacity of Load Cell"*. After recheck the label of load cell and retry the process.

When "mV" is displayed, input Load cell Rated Output (mV), referring the load cell label. And press  key to save.

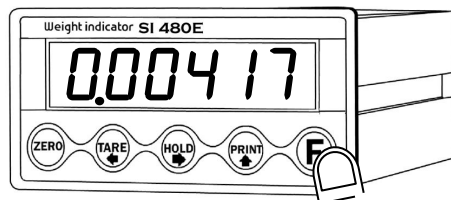

After finishing calculation, calculated "Span value", "DONE" will be displayed.



Now, the Simulation Calibration is done, press  key to complete the calibration process.

Tip In case of multiple pieces of load cells are connected, the rated output will be same as single load cell (Because plural load cells are connected with parallel connection, the sum of rated output voltage is same as single load cell's rated output)

※Due to some variation between "State output rate" and "Real Output rate" of load cell, there might be some weight difference after finishing calibration. If you want to make more precise weighing process, please measure real output rate of load cell and input the measured value. Then the weight measurement will be more precise than before.

5-4. F-FUNCTION Setting

Set-up means set the F-function and make optimal operation of SI 480E controller.

■ Starting F-FUNCTION Mode

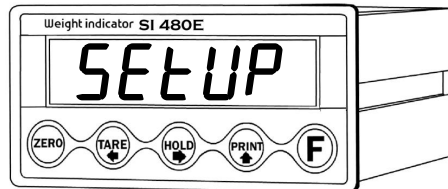

Press  key 4 times → Displaying "SETUP" press  key.

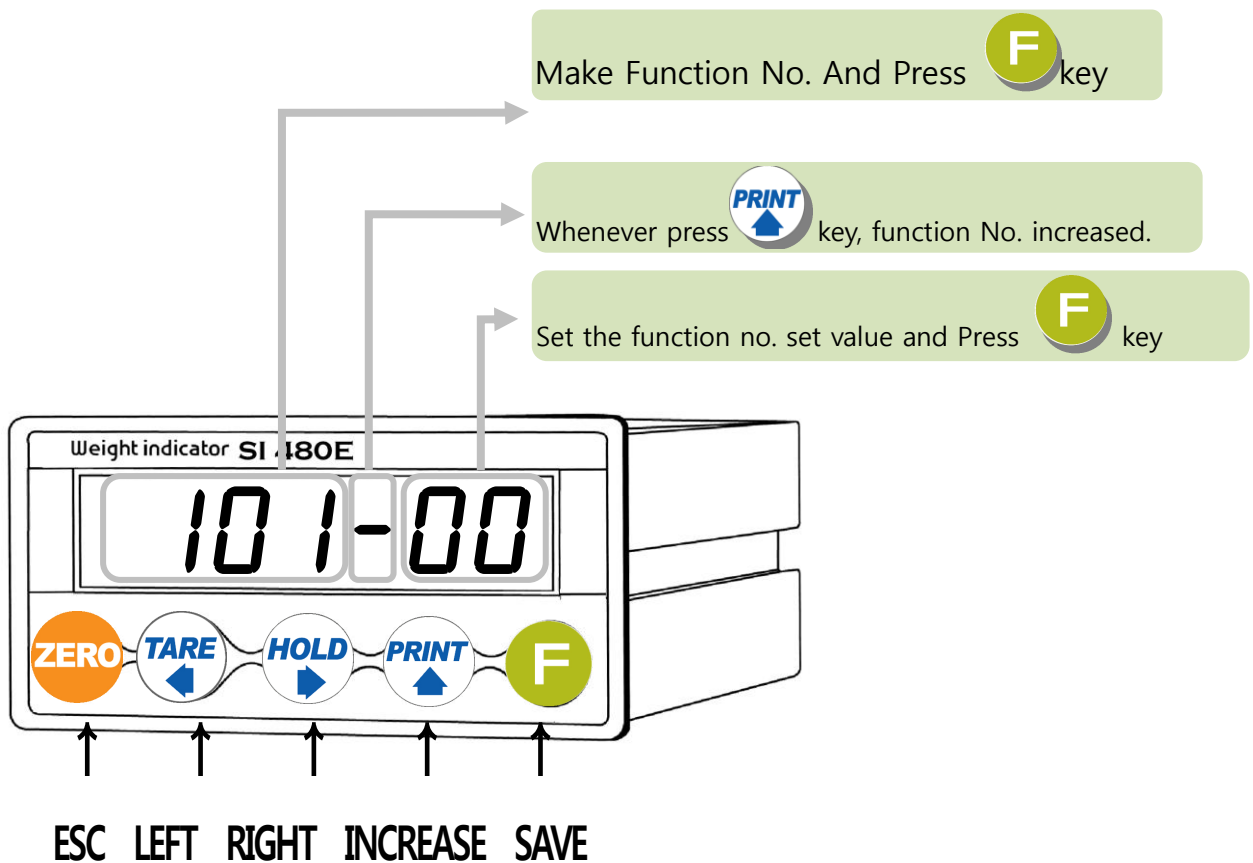

5-4-1 F-FUNCTION list(Summary)

F-list	Subject	Default	Contents
101	Equipment No. setting	01	01~99
102	Weight-Back up Mode	02	00: Normal mode 01: Weight Back up Mode(Zero) 02: Weight Back up Mode(Zero&Tare)
103	Weighing Data Save Method	00	00: Manual(Whenever "Print" key input) 01: Auto(At every steady states) 02: Auto(At the first steady states) 03: Auto(At weighing process finish) 04: Manual& Auto(At every steady states) 05: Manual& Auto (At the first steady states)
104	Display Up-Date Speed	09	01: Slow(1time per 1sec) ~ 09: Fast(60times per 1sec)
108	Buzzer sound (External input detection)	00	00: Buzzer sound, 01: No Buzzer sound
110	Weight Unit	00	00: kg, 01: g, 02: ton
111	Language for print bill	00	00: Korean, 01: English
201	EMPTY Range	100	00~999999
202	Auto Zero Range	00	01~99 (Unit: 0.25 gradation)
203	Steady Range	08	01~99 (Unit: 0.25 gradation)
204	Steady condition check time	10	01~99 (Unit: 0.1 sec)
205	Digital Filter	20	01: Weak vibration ~ 99:Strong vibration
206	Zero key operation mode	00	00: Always active 01: Active under steady condition only
207	Tare Key operation mode	00	00: Always active 01: Active under steady condition only

209	Zero key Operation Range	02	00: Active within 2% of Max Capacity 01: Active within 5% of Max Capacity 02: Active within 10% of Max Capacity 03: Active within 20% of Max Capacity 04: Active within 50% of Max Capacity 05: Active within 100% of Max Capacity 06: No limit
210	Tare key Operation Range	02	00: Active within 10% of Max Capacity 01: Active within 20% of Max Capacity 02: Active within 50% of Max Capacity 03: Active within 100% of Max Capacity
211	Auto Zero function under Tare state	00	00: Disuse 01: Use
212	Tare Delay Time	00	00: Disuse 01 ~ 10: Use (Unit: 1 sec)
213	Auto tare set when weighing starts	00	00: Disuse 01: Use
214	Tare Removal Timing	00	00: Manual 01: Auto at empty range 02: Auto at steady condition
215	Auto Tare Removal Time	00	00: Disuse 00 ~ 09: Use (Unit : 1 sec)
216	Hold Mode	00	00: Sample Hold 01: Peak Hold 02: Average Hold
217	Hold Delay Time	00	00: Disuse, 01~10: Use (Unit: 1 sec.)
218	Hold Removal at the near zero	00	00: Disuse 01: Use
219	Auto Hold Removal Time	00	00: Disuse 01 ~ 10: Use (Unit:1 sec)
220	Average Hold Time	10	01 ~ 99 (Unit: 0.1 sec)
221	Minus (-) Mark Display	00	00: Use 01: Disuse
222	Under UNPASS/OVERLOAD state, Weight display	00	00: Display, 01: No display

233	External Input 1 Setting	01	00: Disuse 01: Zero 02: Tare 03: Tare removal 04: Tare/Tare removal 05: Hold 06: Hold removal 07: Hold/Hold removal 08: Print 09: Subtotal Print
234	External Input 2 Setting	04	00: Disuse 01: Zero 02: Tare 03: Tare removal 04: Tare/Tare removal 05: Hold 06: Hold removal 08: Print 09: Subtotal Print
251	Zero state lamp output standard	00	00: Near Zero 01: Zero
301	Parity / Stop bit	00	00: Data bit 8, Stop bit 1, Parity bit None 01: Data bit 8, Stop bit 1, Parity bit Odd 02: Data bit 8, Stop bit 1, Parity bit Even 03: Data bit 7, Stop bit 1, Parity bit Odd 04: Data bit 7, Stop bit 1, Parity bit Even
302	Serial Communication Speed	02	00: 2,400bps 01: 4,800bps 02: 9,600bps 03: 14,400bps 04: 19,200bps 05: 28,800bps 06: 38,400bps 07: 57,600bps 08: 76,800bps 09: 1115,200bps

303	Data transmission mode	00	00: Simplex / Stream Mode 01: Duplex / Command Mode 02: Print Mode 03: Modbus(RTU)
304	"Check-Sum" under command mode	00	00: Disuse 01: Use
305	Data Format under Stream Mode	00	00: Format 1 01: Format 2 02: Format 3 03: Format 4
306	Date transference under stream mode	00	00: Continuously 01: Single time on every steady state 02: Single time(finish weighing process) 03: When input "PRINT" key
307	Modbus Transmit Data MSB/LSB location	00	00: Standard 01: Change
352	Print Format Setting	00	00: Continuous Print 01: Single Print
354	Print Output Delay Time Setting	00	00~09 (Unit: 1 sec)
355	Paper Withdraw Rate setting (After Continuous/Single Print)	00	00~09 (Unit: 1 line add)
356	Paper Withdraw Rate setting (After SUB/GRAND Total Print)	00	00~09 (Unit: 1 line add)
358	Grand total data delete (After SUB/GRAND Total Print)	00	00: Disuse 01: Use

5-4-2 F-FUNCTION list(Detail)

("●" Factory default)

Equipment No. setting			
101	01	01 ~ 99	ID No. setting with No. key. (01~99 selectable)
Weighing Data Save Method selection			
102		00	Normal mode
		01	Weight Back up Mode(Zero)
	●	02	Weight Back up Mode(Zero&Tare)
Weighing Data Save Method			
103	●	00	Manual(Whenever "Print" key input)
		01	Auto(At every steady states)
		02	Auto(At the first steady states)
		03	Auto(At weighing process finish)
		04	Manual& Auto(At every steady states)
		05	Manual& Auto (At the first steady states)
Display Up-Date Speed			
104	09	01 ~ 09	01: Slow(1 time per 1 sec) ~ 09: Fast(60 times per 1 sec)
Buzzer sound (External input detection)			
108	●	00	Buzzer sound
		01	No Buzzer sound
Weight Unit			
110	●	00	kg
		01	g
		02	ton
Language for print bill			
111	●	00	KOREAN
		01	ENGLISH
EMPTY Range			
201	100	0 ~ 999999	You can set "EMPTY" Range.
Auto Zero Range			
202	00	00 ~ 99	Within the "Auto Zero" range, weighing part is steady, indicator will display current weight as "Zero" If the weighing part is not "Steady", indicator will display current weight. (Unit:0.25 gradation)

Steady Range			
203	08	01 ~ 99	During the set time period, estimate weighing part's "STEADY" condition and display. (Unit: 0.25 gradation)
"STEADY" condition check time			
204	10	01 ~ 99	During the set time period, estimate weighing part's "STEADY" condition and display. If you set small value, indicator will take "STEADY" fast, if you set value, indicator will take "STEADY" slow. (Unit: 0.1 sec)
Digital Filter			
205	20	01 ~ 99	01:Weak vibration ~ 99:Strong vibration
Zero key operation			
206	●	00	Always active
		01	Active under steady condition only
Tare Key operation			
207	●	00	Always active
		01	Active under steady condition only
Zero key Operation Range			
209		00	Active within 2% of Max Capacity
		01	Active within 5% of Max Capacity
	●	02	Active within 10% of Max Capacity
		03	Active within 20% of Max Capacity
		04	Active within 50% of Max Capacity
		05	Active within 100% of Max Capacity
		06	No limit
<p>※ CAUTION: If setting over than 10%, The display weight could be over than Load cell input signal or Max Capacity and it may display "CELL-Err" or incorrect weight value. And It can be the cause of load cell damage.</p>			
Tare key Operation Range			
210		00	Active within 10% of Max Capacity
		01	Active within 20% of Max Capacity
	●	02	Active within 50% of Max Capacity
		03	Active within 100% of Max Capacity
Auto Zero function under Tare state			
211	●	00	Disuse
		01	Use

Tare Delay Time			
212	00	00 ~ 10	00: Disuse 01 ~ 10: Use(Unit: 1 sec)
Auto tare set when weighing starts			
213	●	00	Disuse
		01	Use
Tare Removal Timing			
214	●	00	Manual
		01	Auto at empty range
		02	Auto at steady condition
Auto Tare Removal Time			
215	00	00 ~ 09	Set time to tare removal 00: Disuse 01 ~ 09: Use (Unit : 1 sec)
Hold mode			
216	●	00	Sample Hold: Hold current weight until "Hold Reset"
		01	Peak Hold: Measure Max weight value and hold on display.
		02	Average Hold: Hold average value
Hold delay time			
217	00	00 ~ 10	00: Disuse 01 ~ 10: Use(Unit: 1 sec)
Hold Removal at the near zero			
218	●	00	Disuse
		01	Use
Auto Hold Removal Time			
219	00	00 ~ 10	00: Disuse 01 ~ 10: Use(Unit: 1 sec)
Average Hold Time			
220	10	01 ~ 99	Unit: 0.1 sec
Minus (-) Mark Display			
221	●	00	Display
		01	No display
Under UNPASS/OVERLOAD state, Weight display			
222	●	00	Display
		01	No display

External Input 1 Setting						
233		00	Disuse		05	Hold
	●	01	Zero		06	Hold/Hold removal
		02	Tare		07	Hold/Hold removal
		03	Tare removal		08	Print
		04	Tare/Tare removal		09	Subtotal print
External Input 2 Setting						
234		00	Disuse		05	Hold
		01	Zero		06	Hold/Hold removal
		02	Tare		07	Hold/Hold removal
		03	Tare removal		08	Print
	●	04	Tare/Tare removal		09	Subtotal print
Zero state lamp output standard						
251	●	00	Near Zero			
		01	Zero			
Parity / Stop bit						
301	●	00	DATA Bit (8 Bit)	STOP Bit (1 Bit)	Parity Bit (Non)	
		01	DATA Bit (8 Bit)	STOP Bit (1 Bit)	Parity Bit (Odd)	
		02	DATA Bit (8 Bit)	STOP Bit (1 Bit)	Parity Bit (Even)	
		03	DATA Bit (7 Bit)	STOP Bit (1 Bit)	Parity Bit (Odd)	
		04	DATA Bit (7 Bit)	STOP Bit (1 Bit)	Parity Bit (Even)	







Serial Communication Speed selection			
302		00	2,400bps
		01	4,800bps
	●	02	9,600bps
		03	14,400bps
		04	19,200bps
		05	28,800bps
		06	38,400bps
		07	57,600bps
		08	76,800bps
		09	115,200bps
DATA transference Method selection			
303	●	00	Simplex Mode / Stream Mode
		01	Duplex Mode / Command Mode
		02	Print Mode
		03	MODBUS(RTU)
Command mode "Check Sum" detection selection (F303-01)			
304	●	00	Disuse
		01	Use
Stream mode DATA Transference Format selection (Refer chapter 6-1-4)			
305	●	00	Format 1 (19byte)
		01	Format 2 (22byte)
		02	Format 3 (17byte)
		03	Format 4 (22byte)
Stream mode Data transference			
306	●	00	Continuously
		01	Single time on every steady state
		02	At the first steady point
		03	Single time(when finish weighing process)
		04	When input "PRINT" key
Modbus Transmit Data MSB/LSB location			
307	●	00	Standard
		01	Change



Print Format			
352	●	00	Continuous Print
		01	Single Print
Print Output Delay Time			
354	00	00 ~ 09	Unit: 1 sec
Paper Withdraw Rate setting(After Continuous/Single Print)			
355	00	00 ~ 09	Unit: 1 line add
Paper Withdraw Rate setting(After SUB/GRAND Total Print)			
356	00	00 ~ 09	Unit: 1 line add
Grand total data delete			
358	●	00	Disuse
		01	Use

◆ Weighing Data Saving time point and print

Weighing Data Save Method (F-function 103)		Print input (Key, Comm., External input)	Printing out data	Saving Data
00	Manual	○	Current weight	Current weight
		X	X	X
01	Auto: At every steady states	○	Recent Stable weight	X
		X	Steady weight	Steady weight
02	Auto: At the first steady states	○	Recent Stable weight	X
		X	Steady weight	Steady weight
04	Manual& Auto: At every steady states	○	Current weight	Current weight
		X	Steady weight	Steady weight
05	Manual& Auto: At the first steady states	○	Current weight	Current weight
		X	Steady weight	Steady weight
06	Manual / Auto : When weighing is finished	○	Current weight	Current weight
		X	Finish weight	Finish weight

5-4-3. Hidden Option

How to enter Hidden function setting mode : Press  Key during 4sec and input your password. Default password is     (1111). Press  key after input your password. Then show "SET.CAL" on the screen press "" key.

F-LIST	Subject	Default	Contents
HF01	Serial Number Check	-	-
HF03	S/W Version Check	-	Program version check
HF04	H/W Version Check	-	-
HF05	DATE(Y,M,D) Check	-	Able to modify
HF06	TIME(H,M,S) Check	-	Able to modify
HF07	Password Setting (4 digit)	-	1:TARE Key  2:HOLD Key  3:PRINT Key  (Password combination within 1~3)
HF08	Maximum Capacity Weight Check	-	Able to modify
HF19	Function List Factory Reset	-	Change to default F-setting



5-5. Test Mode



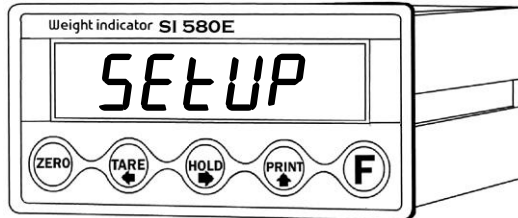









Before starting the TEST mode, please remove operating devices.



Press  key 4 times → On the screen "SETUP"

- Test mode 1: Press  key
- Test mode 2: Press  key
- Cancel / Go back: Press  key.

TEST MODE 1				
				
ESC / BACK	Analog Deviation Check Mode	Display Check Mode	Key Check Mode	
TEST MODE 2				
				
ESC / BACK	External input Check Mode		Standard Serial I/F Check Mode	

Tip If there is no change although pressing keys or loading some force on/in weighing part, it may something wrong with load cell, cable, connector or A/D board

5-5-1. Analog Deviation Check Mode

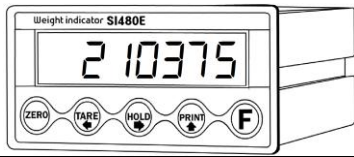

You can check the deviation of analog value.

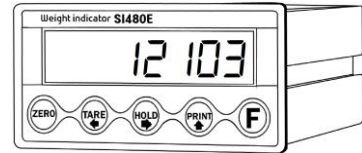
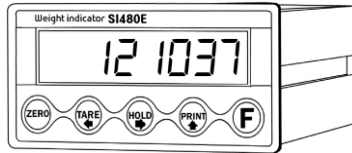
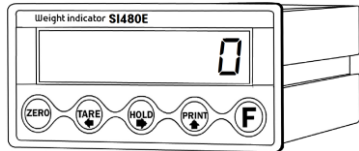

Display current analog value to '0'



Display from 1 million unit



Display from ten million unit

5-5-2. Display check mode

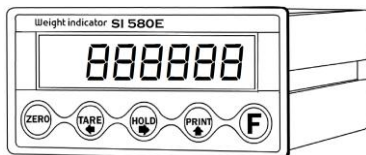

Test FND and LED
Blink FND and LED by 1 Segment gradually.

5-5-3. Key check mode

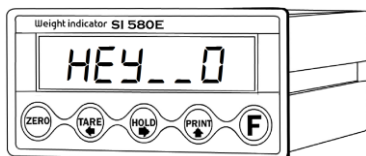

Press each key on the screen show
"1", "2", "3", "4", "5"

5-5-4. External input check mode

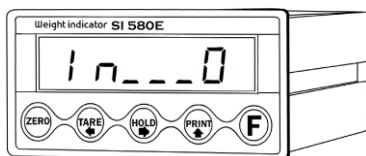

Connect external input on the screen show
"1", "2", "3", "4".

5-5-5. Standard Serial Interface Test Mode.

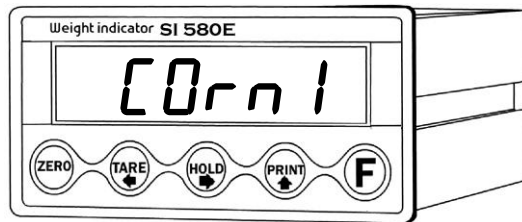

Connect with PC or other devices through serial interface and check the transference and receipt. At the normal operation, display will be blinked.

※ TESTING PROTOCOL.

Format: STX Id No. TEST ETX

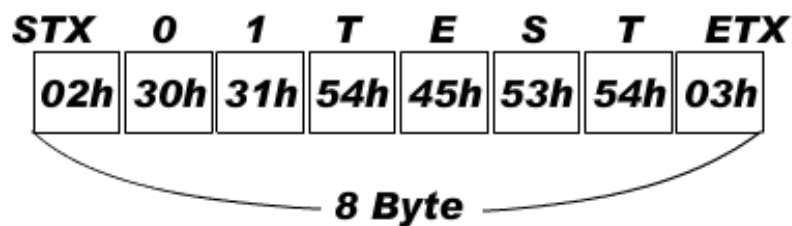

You cannot test Standard and Extended Serial Interface at the same time.

※ If you send "Testing protocol" from PC to Indicator, at the normal operation Display will blink.

6. INTERFACE

6-1-1. Serial Interface (RS – 485: Standard installed, Selectable)

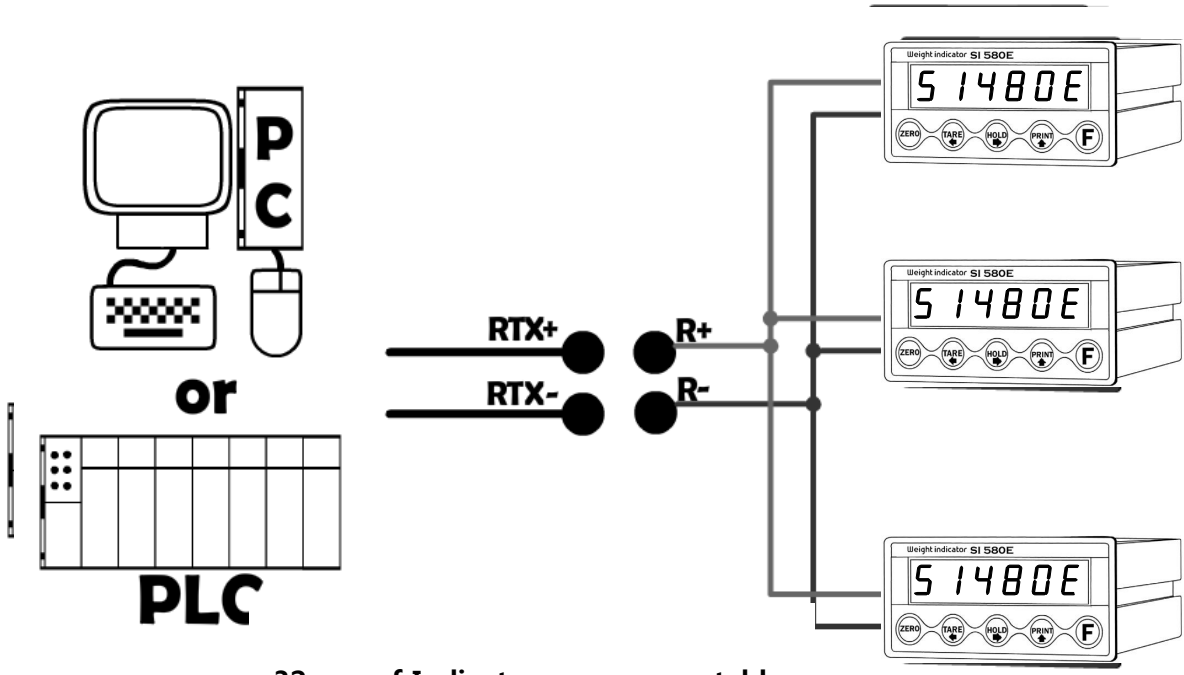

32 pcs of Indicators are connectable.

6-1-2. Serial Interface (RS – 422: Standard, Selectable)

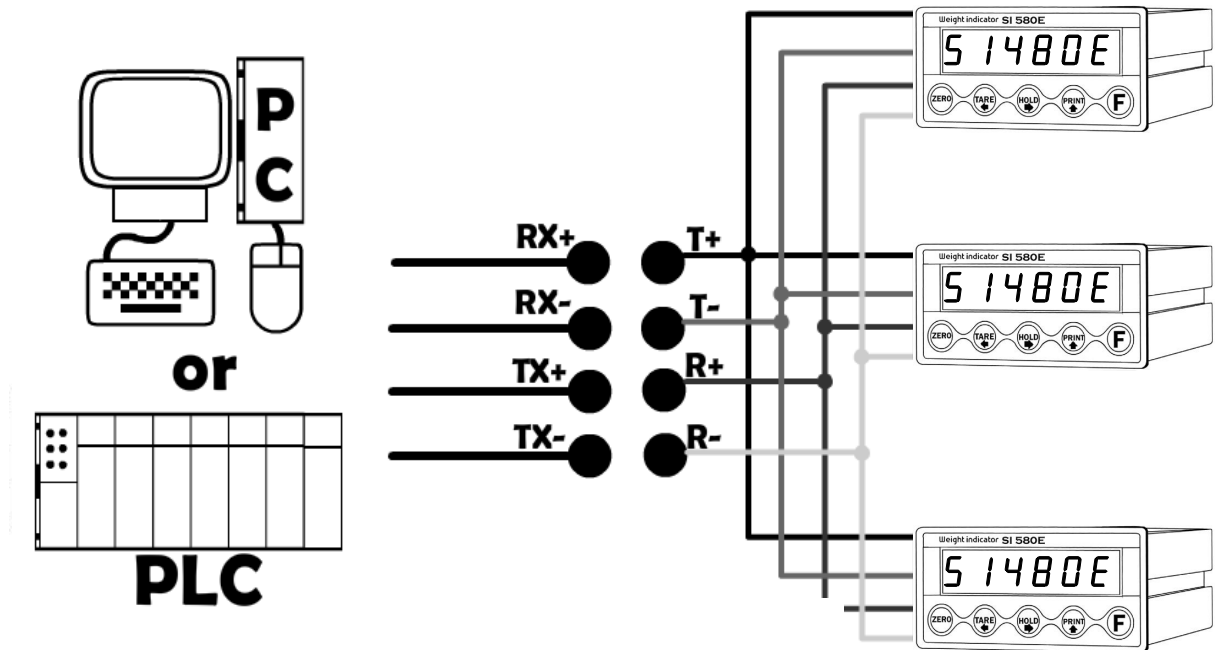

32 pcs of Indicators are connectable.

6-1-3. Serial Interface (RS – 232 order spec)

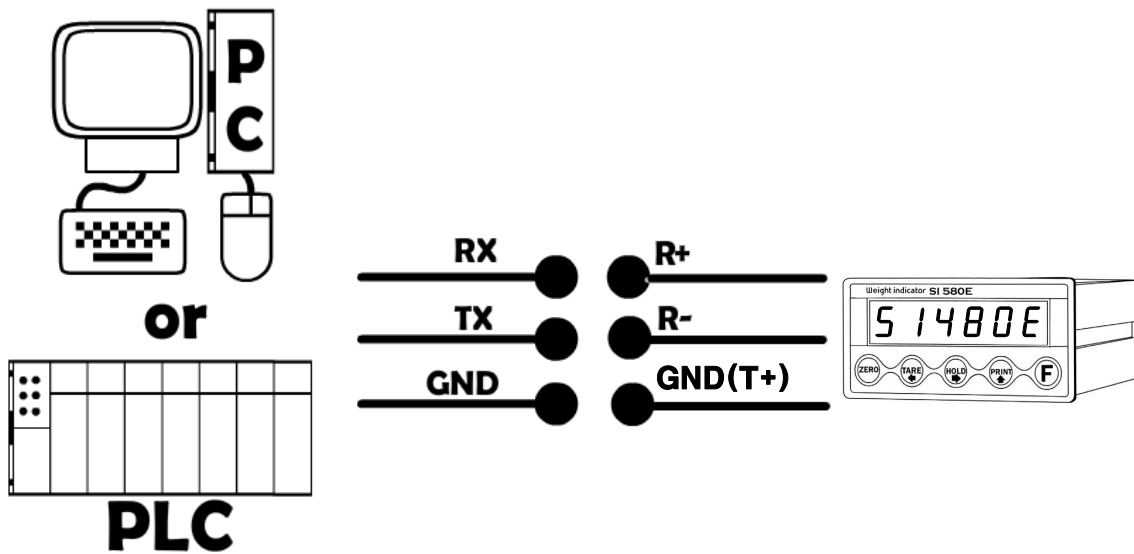

Serial communication interface is sensitive to electric noise. Install isolated place from Power cable or other electric cables and wires, and please use shielded cable for better performance.

6-1-4. Data Format

1. Format 1: ID Number is not be transferred.(Refer F305-00 / 19 byte)

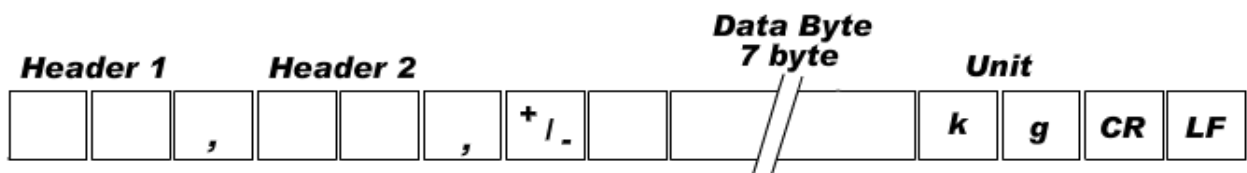

Header1	Header2
OL : OVER LOAD	NT : NET-WEIGHT(Tare is not set)
ST : STEADY	GS : when setting TARE
US : UNSTEADY	

2.Format 2: ID Number + Data Transference (Refer F305-01 / 22 byte)

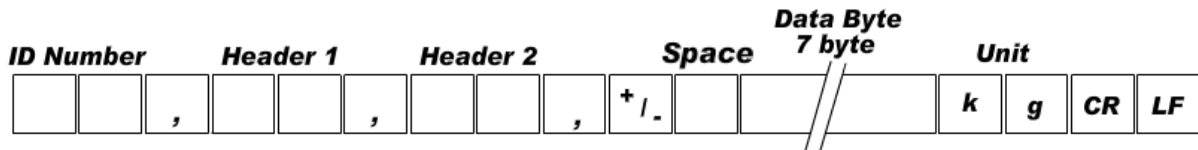

Header1	Header2
OL : OVER LOAD	NT : NET-WEIGHT(Tare is not set)
ST : STEADY	GS : when setting TARE
US : UNSTEADY	

3. Format 3: ID Number + State (Refer F305-02 / 17 byte)

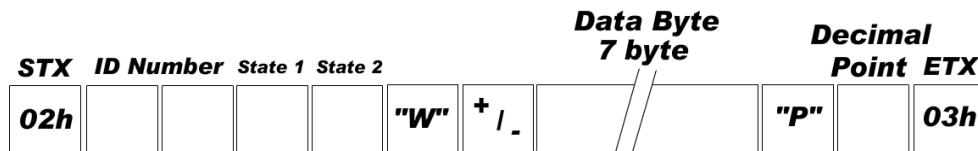

Header1	Header2
O : OVER	G : Gross weight
S : STEADY	N : Net weight
U : UNSTABLE	

4. Refer F305-03 / 22 byte

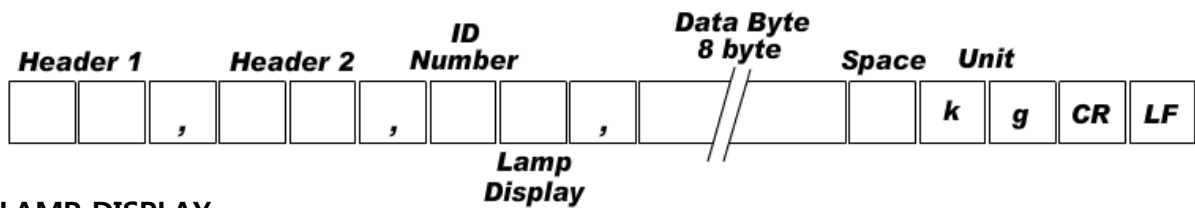

LAMP DISPLAY

Bit 7	Bit 6	Bit 5	Bit 4	Bit 3	Bit 2	Bit 1	Bit 0
1	0	1	1	1	1	1	1
1	STEADY	1	Hold	Print	Gross Weight	TARE	ZERO

Header1	Header2
OL : OVER LOAD	NT : GROSS weight
ST : STEADY	GS : Net weight
US : UNSTEADY	

6-1-5. Command Mode

Under "Command Mode", Indicator will recognize the receipt of Order based on 02h(STX) and 03h(ETX) signal, and transfers 06h(ACK), 15h(NAK).

Error Code (Function 304 - 01 or 311 - 01)			
0 (30h)	Normality	3 (33h)	Number data Error
1 (31h)	Check-Sum Error	4 (34h)	Excess of write data's allowable range
2 (32h)	Data length Error		

6-1-6. Read Command

Subject	Command	Length of transmission data
Current Weight	STX ID RCWT ETX	22 byte
Current data	STX ID RCWD ETX	46 byte
Current date data	STX ID RDAT ETX	14 byte
Current time data	STX ID RTIM ETX	14 byte
Tare weight	STX ID RTAR ETX	18 byte

6-1-7. Write Command

Subject	Command	Length of transmission data
Zero	STX ID WZER ETX	8 byte
Tare	STX ID WTAR ETX	8 byte
Tare Reset	STX ID WTRS ETX	8 byte
Hold	STX ID WHOL ETX	8 byte
Hold Reset	STX ID WHRS ETX	8 byte
Print	STX ID WPRT ETX	8 byte
Grand total Print	STX ID WGPR ETX	8 byte
Delete Grand total	STX ID WGTC ETX	8 byte
Date setting	STX ID WDAT DATE (YYMMDD) ETX	14 byte
Time setting	STX ID WTIM TIME (HHMMSS) ETX	14 byte

6-1-8. Read Command Detail

Current Weight														
ASCII : STX ID(2byte) RCWT ETX							HEX : 02 30 31 52 43 57 54 03							
Response	STX ID RCWT State1(1byte) State2(1byte) P decimal point(1byte) +/- (1byte) Current weight(7byte) Weight unit(2byte) ETX													
	State1 : O(Over Load) , S(Steady), U(Unsteady) State2 : N(Net weight), G(Gross weight)													
Ex) Steady(S), TARE not used(N), 0.000kg														
STX	ID	R	C	W	T	S	N	P	3	+	0	0	0	
02h	30h	31h	52h	43h	57h	54h	53h	4Eh	50h	33h	2Bh	30h	30h	30h
0	0	0	0	k	g	ETX								
30h	30h	30h	30h	6Bh	67h	03h								
Indicator memory data														
ASCII : STX ID(2byte) RCWD ETX							HEX : 02 30 31 52 43 57 44 03							
Response	STX ID RCWD P decimal point(1byte) date(6byte) Time(6byte) No. of weighing(6byte) +/- (1byte) Tare(7byte) +/- (1byte) weight(7byte) weight unit(2byte) ETX													
	Ex) DATE : Aug 12 th ,2014, TIME : 12:00:00, the no. of weighing : 10, TARE : 2.000kg, current weight : 3.000kg													
STX	ID	R	C	W	D	P	3	1	4	0	1	0	1	
02h	30h	31h	52h	43h	57h	44h	50h	33h	31h	34h	30h	31h	30h	31h
1	2	0	0	0	0	0	0	0	0	1	0	+	0	0
31h	32h	30h	30h	30h	30h	30h	30h	30h	30h	31h	30h	2Bh	30h	30h
0	2	0	0	0	+	0	0	0	3	0	0	0	k	g
30h	32h	30h	30h	30h	2Bh	30h	30h	30h	33h	30h	30h	30h	6Bh	67h
ETX														
03h														

Grand Total data														
ASCII : STX ID(2byte) RGRD ETX	HEX : 02 30 31 52 47 52 44 03													
Response	STX ID RGRD P decimal point(1byte) the no. of weighing (6byte) Accumulated weight(10byte) unit(2byte) ETX													
Ex) the no. of weighing : 10 , Accumulated Weight : 10.000kg														
STX	ID R G R D P 3 0 0 0 0 1 0													
02h	30h	31h	52h	47h	52h	44h	50h	33h	30h	30h	30h	30h	31h	30h
0	0	0	0	0	1	0	0	0	0	0	k	g	ETX	
30h	30h	30h	30h	30h	31h	30h	30h	30h	30h	6Bh	67h	03h		
Current Time data														
ASCII : STX ID(2byte) RTIM ETX	HEX : 02 30 31 52 54 49 4D 03													
Response	STX ID RTIM Current Time(6byte) ETX													
예) 시간 : 12:00:00														
STX	ID R T I M 1 2 0 0 0 0 ETX													
02h	30h	31h	52h	54h	49h	4Dh	31h	32h	30h	30h	30h	30h	03h	
Current date data														
ASCII : STX ID(2byte) RDAT ETX	HEX : 02 30 31 52 44 41 54 03													
Response	STX ID RDAT Current Date(6byte) ETX													
Ex) Date : Aug 12 th ,2014														
STX	ID R D A T 1 4 0 1 0 1 ETX													
02h	30h	31h	52h	44h	41h	54h	31h	34h	30h	31h	30h	31h	03h	
Tare data														
ASCII : STX ID(2byte) RTAR ETX	HEX : 02 30 31 52 54 41 52 03													
Response	STX ID RTAR P decimal point(1byte) +/- (1byte) TARE value(7byte) ETX													
Ex) TARE : 2.000kg														
STX	ID R T A R P 3 + 0 0 0 2 0													
02h	30h	31h	52h	54h	41h	52h	50h	33h	2Bh	30h	30h	30h	32h	30h
0	0	ETX												
30h	30h	03h												

6-1-9. Write Command Detail

Zero (same as "ZERO" key)	
ASCII : STX ID(2byte) WZER ETX	HEX : 02 30 31 57 5A 45 52 03
Response	Normal : STX ID ACK ETX Error : STX ID NAK ETX
TARE	
ASCII : STX ID(2byte) WTAR ETX	HEX : 02 30 31 57 54 41 52 03
Response	Normal : STX ID ACK ETX Error : STX ID NAK ETX
TARE reset	
ASCII : STX ID(2byte) WTRS ETX	HEX : 02 30 31 57 54 52 53 03
Response	Normal : STX ID ACK ETX Error : STX ID NAK ETX
HOLD	
ASCII : STX ID(2byte) WHOL ETX	HEX : 02 30 31 57 48 4F 4C 03
Response	Normal : STX ID ACK ETX Error : STX ID NAK ETX
HOLD reset	
ASCII : STX ID(2byte) WHRS ETX	HEX : 02 30 31 57 48 52 53 03
Response	Normal : STX ID ACK ETX Error : STX ID NAK ETX
PRINT	
(Data will be transferred to the port which is set as print mode -Function 303,310 - 02)	
ASCII : STX ID(2byte) WPRT ETX	HEX : 02 30 31 57 50 52 54 03
Response	Normal : STX ID ACK ETX Error : STX ID NAK ETX
Grand Total Print	
(Data will be transferred to the port which is set as print mode -Function 303,310 - 02)	
ASCII : STX ID(2byte) WGPR ETX	HEX : 02 30 31 57 47 50 52 03
Response	Normal : STX ID ACK ETX Error : STX ID NAK ETX
Grand Total Delete	
ASCII : STX ID(2byte) WGTC ETX	HEX : 02 30 31 57 47 54 43 03
Response	Normal : STX ID ACK ETX Error : STX ID NAK ETX
Date Setting	
ASCII : STX ID(2byte) WDAT data(6byte) ETX	
Ex) Date : Aug 12 th ,2014	
STX	 ID W D A T 1 4 0 1 0 2 ETX
02h	30h 31h 57h 44h 41h 54h 31h 34h 30h 31h 30h 32h 03h
Response	Normal : STX ID ACK ETX Error : STX ID NAK ETX

Time Setting													
ASCII : STX ID(2byte) WTIM time(6byte) ETX													
예) 12:00:00													
STX	ID	W	T	I	M	1	2	0	0	0	0	0	ETX
02h	30h	31h	57h	54h	49h	4Dh	31h	32h	30h	30h	30h	30h	03h
Response	Normal : STX ID ACK ETX Error : STX ID NAK ETX												

Tip How to Calculate Check sum

Sum the value from "STX" to "ETX" and converts to ASCII(2byte) and transfer.

Convert the Sum value(HEX) to ASCII and transmit(28byte) .

ex) The sum HEX value from STX to ETX(02,30,31,52,43,57,54,03) is 1A6h.

Then, divide 1A6h by 100h(1A6h/100h). the rest of result is A6h.

Calculated remainder value is A6h, then convert A6h to ASCII, 41(A), 36(6), and transfer

6-1-10. Modbus Memory Map

Tip

- RO : Read Only
- RW : Read Write
- Each P/N's set point can't over max capacity of Indicator.
ex) 35.00kg = 3,500 (0xDAC)
- When you input date and time, it should be 6digit.
ex) 1st January 2014 = 140101 (0x22345)
15(H) : 50(M) : 17(S) = 155017 (0x25D89)
- Refer the memory register for regarding Lamp, Error, Digital Input, Standard Key, Special Key
- Modbus Function Codes
 - '03' (0x03) : Read Holding Registers
 - '04' (0x04) : Read Input Registers
 - '06' (0x06) : Write Single Registers
 - '16' (0x10) : Write Multiple Registers
- CRC Check Method is CRC-16.

Ad.	Length	Feature	Description
1	2	RO	Capacity
3	2	RO	None(0x00)
5	2	RO	Analog Value
7	2	RO	Span Value
9	1	RO	Division
10	1	RO	Decimal point
11	2	RO	Current Weight
13	2	RO	Tare Weight
15	2	RO	Measured Weight
17	2	RO	Digital input
19	2	RO	Lamp
21	2	RO	Error
33	2	RO	Grand total Count
35	2	RO	Grand total Weight

437	2	RW	Date
439	2	RW	Time
441	1	RW	Key value

6-1-11. Modbus memory register

(1) Digital input register (Address : 17, Length : 2)

0	1	2	3
INPUT1	INPUT2	INPUT3	INPUT4

(2) Lamp register (Address : 19, Length : 2)

0	1	2	3	4	5	6	7
Steady	Zero	Tare	OUT1	OUT2	OUT3	OUT4	Hold

(3) Error register (Address : 21, Length : 2)

0	1	2
Load cell Error	Over Load	Set point Error

(4) Key register (Address : 441, Length : 1)

0	1	2	3	4	5	6	7	8	9	10	11
Start	Stop	Zero	Tare	Tare Removal	Hold	Hold Removal	Print	Sub- total print	Sub- total delete	Grand total Print	Grand total delete

(5) Relay output register (Address : 443, Length : 1)

0	1	2	3
OUT1	OUT2	OUT3	OUT4

SI 480E DIN SIZE WEIGHING CONTROLER

6-2 Serial Print (F303 or F310-02 setting) – RS-232 Serial Interface.

It can be connected with all kinds of Serial interface printer, but the printing format is already programmed and fixed with SE7200/7300 model.

6-2-1. Printing Format

Using the RS-485 or 422 interface, please use convertor and converts to RS-232 and connect with Serial printer.

If you use RS-232 serial interface, connect directly without any convertor.

English Format (F111-01)

```
=====
DATE :          2009-05-10
TIME :          18:00:10
COUNT          WEIGHT
   1            + 1.330kg
   2            + 5.350kg
   3            + 1.380kg
   4            + 2.330kg
```

Continuous Print Format(F352-01)

```
=====
DATE :          2009-05-10
TIME :          18:00:10
COUNT          WEIGHT
   2            + 5.350kg

=====
DATE :          2009-05-10
TIME :          18:00:10
COUNT          WEIGHT
   3            + 1.280kg
```

Single Print Format(F352-00)

```
=====
TOTAL
DATE :          2009-05-10
TIME :          18:00:10
COUNT :        10
TOTAL WEIGHT :  258.145kg
=====
TOTAL DELETE
=====
```

Grand Total Print delete(F358-01)

SI 480E DIN SIZE WEIGHING CONTROLER

7. Error & Treatment

7-1. Load Cell Installation

Error	Cause	Treatment	Remarks
Weight Value is unstable	1) Load cell broken 2) Load cell isolation resistance error 3) Weighing part touches other devices or some weight is on the weighing part 4) Summing Board Error	1) Measure input/output resistance of Load cell. 2) Measure Load cell isolation resistance	1. Input Resistance of "EXC+" and "EXC-" is about $400\Omega \pm 30$ 2. Output Resistance of "SIG+" and "SIG-" is about $350\Omega \pm 3.5$ 3. Isolate Resistance is more than $100M\Omega$
Weight Value is increased regular rate, but not return to "Zero"	1) Load cell Error 2) Load cell connection Error	1) Check Load cell connection 2) Measure Load cell Resistance	
Weight Value is increased to under Zero	Load cell Output wire (SIG+, SIG-) is switched	Make wire correction	
"UnPASS"	Load cell broken or Indicator connection Error	Load cell Check Load cell connection Check	
	Power was "ON" when some weight is on the load cell.	Remove weight on the Load cell	
"Over" (Over Load)	1) Load cell broken or Indicator connection Error 2) Loading over than Max Capacity	1) Load cell Check 2) Load cell connection Check 3) Remove over loaded weight	

SI 480E DIN SIZE WEIGHING CONTROLER

7-2. Calibration Process

Display	Cause	Treatment
Err-01	When Max capacity/digit value is over 20,000	Re-input the Max Capacity, less than 20.00 (Max Capacity / Digit)
Err-04	Standard weight value is over than Max Capacity	Re-input Standard weight value with Number keys, under Max Capacity
Err-05	Standard weight value is less than 10% of Max Capacity	Re-input Standard weight value with Number keys, more than 10% of Max Capacity
Err-06	1. Amp. Gain is too big 2. Sig+ and Sig- wire connection error 3. Test weight is not loaded	Check standard weight's weight with set value. If there is difference between set value and real weight, please re-input the value (set value is too small)
Err-07	1. Amp. Gain is too small 2. Sig+ and Sig- wire connection error 3. Test weight is not loaded	Check standard weight's weight with set value. If there is difference between set value and real weight, please re-input the value (set value is too big)
Err-08	Under "F-function" model, set value is "N.A"	Check the correct value and re-input
Err-A	When there is continuous vibration on the weighing part,, indicator cannot process calibration any more.	- Find vibration cause and remove - Load cell check - Load cell cable and connecting condition check

SI 480E DIN SIZE WEIGHING CONTROLLER

7-3. Digital Weighing Indicator

Display	Cause	Treatment
<p>"CELL"</p> <p>or</p> <p>"OVER"</p>	<ol style="list-style-type: none"> 1. Load cell Error 2. Load cell cable Error 3. Load cell connection Error 4. A/D Board Error 5. If Analogue value is over 1,040,000. <p>※ When weigh "-" value, If it is over set max capa, "OVER" is displayed. Ex) Even though set max capa is "100" and it is over "-100", "OVER" is displayed.</p>	<ol style="list-style-type: none"> 1. Under "TEST" mode 1, check analogue value. If you cannot get any analogue value or there is no change although adding load, please check load cell, load cell cable, connection conditions first. 2. Replace another load cell, and check the indicator condition. If you have same problem, please replace new indicator and check A/D board error. 3. Try to connect the indicator's A/D with the other indicator. 4. Check the power and connection of terminal.
"UnPASS"	<ol style="list-style-type: none"> 1. Power is ON, when some materials are on weighing part. <p>※ Under "Normal Mode", if there are more than 20% loading of Max capacity, "Un-Pass" display will be appeared and indicator will stay until removing the load.</p> <p>※ Setting Back-up mode it can memory empty value, and it becomes set value without displaying "Un-pass"</p>	<ol style="list-style-type: none"> 1. If you set "Normal Mode", please check weighing part empty or not before turn on the power. If there are some materials in/on weighing part, please remove those materials and turn on the power. 2. Please try to set F102-01(Back-up) mode so that the indicator can remember first empty value.
"SETt in"	<p>When Power is on, "SET" displays. It means EEPROM has some problem.</p>	Please contact the distributor or Head Office.
"HALt"	<p>H/W has some problem.</p>	
"t-Err"	<p>The dead Battery</p>	

※ "CELL-Err" on the screen relay output, Analog output, ZERO and PRINT key not activate

SI 480E DIN SIZE WEIGHING CONTROLER

WARRANTEE CETIFICATION		
<p>This product is passed SEWHACNM strict quality test.</p> <p>If there is defect of manufacturing or abnormal detection within warrantee period, please contact our Agent or Distributor with this Warrantee certificate.</p> <p>Then, we will repair or replace free of charge.</p>		
WARRANTEE CLAUSE		
<p>1. The Warrantee period, we can guarantee, is one(1) year from your purchasing date</p> <p>2. Warrantee Exception Clause</p> <ul style="list-style-type: none"> - Warrantee period is expired. - Any kinds of Mal-function or defection caused by Modification or Repair without SEWHACNM permission. - Any kinds of Mal-function, Defection, or External damage, caused by operator - Any kinds of Mal-function, Defection, caused by using spare part from Non-Authorized Distributor or Agent. - Any kinds of Mal-function, Defection, caused by not following Warnings or Cautions mentioned on this manual. - Any kinds of Mal-function, Defection caused by "Force Majeur", like Fire, Flood. - Without presentation of this "Warrantee Certification". <p>3. Other</p> <ul style="list-style-type: none"> - Any kinds of "Warrantee Certification" without authorized Stamp is out of validity 		
<p>SEWHACNM Co.,Ltd.</p> <p>#504-302, 397, Seokcheon-ro, Ojeong-gu, Bucheon-si, Gyeonggi-do, Korea</p> <p>Made in KOREA</p> <p>Website : http://www.sewhacnm.co.kr , Email : sales@sewhacnm.co.kr</p>	<p>Product</p> <p>Model</p> <p>Serial No.</p> <p>AUTHORIZED STAMP</p>	<p>Digital Weighing Indicator</p> <p>SI 480E</p> <div style="text-align: center;">  </div>